



TESLA

MODEL X OWNER'S MANUAL



2018.12
March 22, 2018



Overview.....2
 Interior Overview.....2
 Exterior Overview.....3

Opening and Closing..... 4
 Doors.....4
 Windows.....12
 Rear Trunk.....13
 Front Trunk.....15
 Glove Box.....17
 Cup Holders.....18
 Sun Visors.....19

Seating and Safety Restraints..... 20
 Front and Rear Seats.....20
 Seat Belts.....27
 Child Safety Seats.....30
 Airbags.....38

Driving.....42
 Driver Profiles.....42
 Steering Wheel.....44
 Mirrors.....47
 Starting and Powering Off.....48
 Gears.....50
 Instrument Panel.....51
 Lights.....57
 Wipers and Washers.....61
 Brakes.....62
 Traction Control.....64
 Park Assist.....65
 Vehicle Hold.....67
 Acceleration Modes.....68
 Trip Information.....70
 Getting Maximum Range.....71
 Rear View Camera.....73
 Active Spoiler.....74
 Towing and Accessories.....75

Driver Assistance..... 84
 About Driver Assistance.....84
 Traffic-Aware Cruise Control.....87
 Autosteer.....93
 Auto Lane Change.....96
 Autopark.....98
 Lane Assist.....103
 Collision Avoidance Assist.....105
 Speed Assist.....109

Using the Touchscreen.....111
 Touchscreen Overview.....111
 Controls.....116
 Settings.....119
 Climate Controls.....123
 Smart Air Suspension.....129
 Media and Audio.....131
 Phone.....136
 Maps and Navigation.....138
 Calendar.....143
 Security Settings.....144
 HomeLink Universal Transceiver.....145
 Connecting to Wi-Fi.....147
 Software Updates.....148
 Mobile App.....149

Charging..... 150
 Electric Vehicle Components.....150
 Battery Information.....152
 Charging Instructions.....154

Maintenance..... 159
 Maintenance Schedule.....159
 Tire Care and Maintenance.....160
 Cleaning.....166
 Wiper Blades and Washer Jets.....169
 Fluid Reservoirs.....170
 Jacking and Lifting.....172
 Parts and Accessories.....173

Specifications..... 174
 Identification Labels.....174
 Vehicle Loading.....175
 Dimensions and Weights.....178
 Subsystems.....181
 Wheels and Tires.....183

Roadside Assistance.....190
 Contacting Roadside Assistance.....190
 Instructions for Transporters.....191

Consumer Information..... 193
 Easter Eggs.....193
 About this Owner Information.....194
 Disclaimers.....195
 Reporting Safety Defects.....197
 Declarations of Conformity.....198

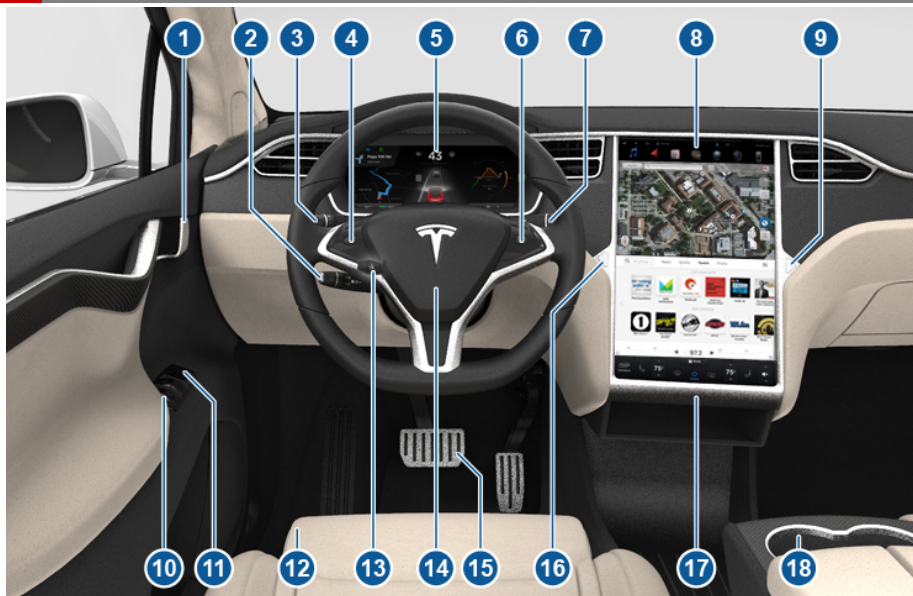

1. Interior door handles ([Opening Doors from the Interior](#) on page 7)
2. Traffic-Aware Cruise Control ([Traffic-Aware Cruise Control](#) on page 87) and Autosteer ([Autosteer](#) on page 93)
3. High beams ([High Beam Headlights](#) on page 59), Turn signals ([Turn Signals](#) on page 59), Wipers and washers ([Wipers and Washers](#) on page 61)
4. Steering wheel buttons - left ([Using Left Steering Wheel Buttons](#) on page 44)
5. Instrument panel ([Instrument Panel](#) on page 51)
6. Steering wheel buttons - right ([Using Right Steering Wheel Buttons](#) on page 45)
7. Gear selector ([Shifting Gears](#) on page 50)
8. Touchscreen ([Touchscreen Overview](#) on page 111)
9. Glovebox button ([Glove Box](#) on page 17)
10. Power window switches ([Opening and Closing](#) on page 12)
11. Exterior mirror adjustment switches ([Mirrors](#) on page 47)
12. Seats ([Front and Rear Seats](#) on page 20)
13. Steering column adjuster (hidden from view in the above image) ([Steering Wheel](#) on page 44)
14. Horn ([Horn](#) on page 46)
15. Brakes ([Brakes](#) on page 62)
16. Hazard warning lights ([Hazard Warning Flashers](#) on page 60)
17. Cabin climate control ([Climate Controls](#) on page 123)
18. Cup holders ([Cup Holders](#) on page 18)

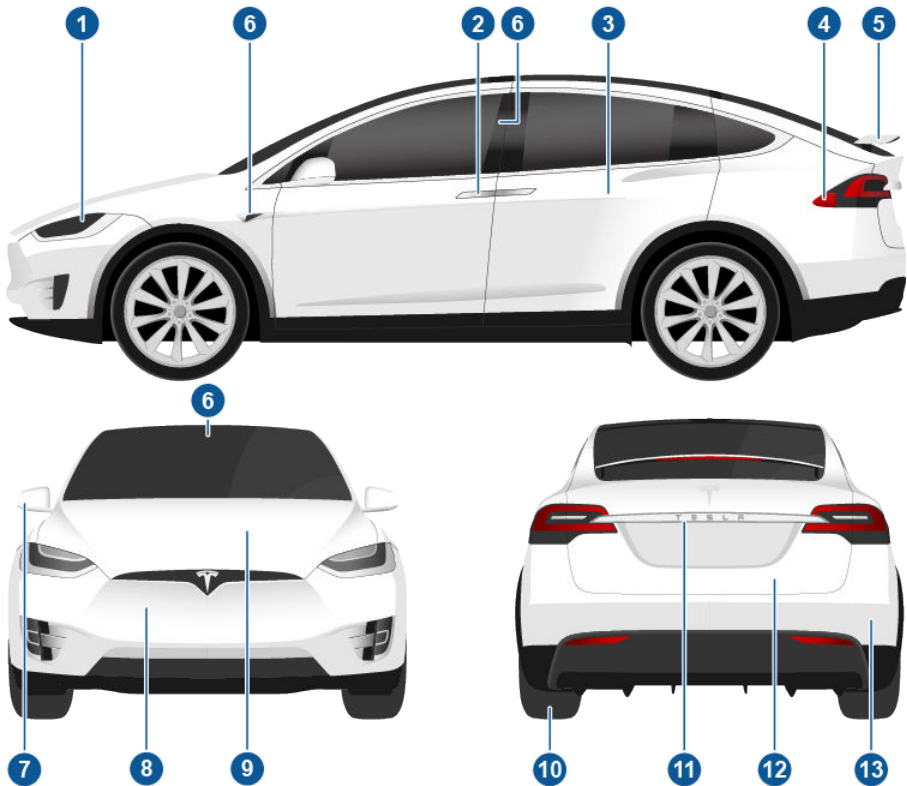

1. Exterior lights ([Lights](#) on page 57)
2. Front doors ([Opening and Closing Front Doors from Outside Model X](#) on page 7)
3. Falcon wing doors ([Doors](#) on page 4)
4. Charge port ([Charging Instructions](#) on page 154)
5. Active spoiler (optional) ([Active Spoiler](#) on page 74)
6. Driver Assistance cameras ([About Driver Assistance](#) on page 84)
7. Exterior mirrors ([Mirrors](#) on page 47)
8. Radar sensor (hidden from view in the above image) ([About Driver Assistance](#) on page 84)
9. Hood/Front trunk ([Front Trunk](#) on page 15)
10. Wheels and tires ([Wheels and Tires](#) on page 183)
11. Rear view camera ([Rear View Camera](#) on page 73 and [About Driver Assistance](#) on page 84)
12. Rear trunk/liftgate ([Rear Trunk](#) on page 13)
13. Ultrasonic sensors ([Park Assist](#) on page 65 and [About Driver Assistance](#) on page 84)



Keyless Locking and Unlocking

Locking and unlocking Model X is convenient. Although you must be carrying a valid key, there is no need to use it. Model X has sensors around the driver's door that can recognize the presence of a key within a range of approximately three feet (one meter). So, you can keep your key in your pocket or purse and Model X detects it as you approach.

When you walk up to Model X carrying your key, the doors automatically unlock if Passive Entry is on. To open the rear trunk, press the switch located under the trunk's exterior handle.

Note: Model X must detect your key near the driver's door before the doors or rear trunk unlock.

Note: If Passive Entry is off, you must use the key to unlock Model X. See [Using the Key](#) on page 4.

If equipped with the premium upgrade package, and the **Automatic Doors** setting is turned on, when you walk up to Model X carrying your key, doors automatically unlock and the driver's door partially opens. If not equipped, or if this setting is turned off, doors automatically unlock and a door opens when you press its handle.

Note: You can choose whether you want all doors, or just the driver's door, to unlock when you approach Model X carrying your key (see [Door Unlock Mode](#) on page 10).

When carrying your key with you, you can also open the rear trunk without having to use the key. Simply press the switch located under the trunk's exterior handle. Door Unlock Mode (see [Door Unlock Mode](#) on page 10) must be set to **All** and the vehicle must detect the key near the driver's door before opening the rear trunk.

Model X also locks automatically. If you set **Walk-Away Door Lock** to **ON**, Model X locks when you walk away carrying your key with you (see [Walk-away Locking](#) on page 10).

While sitting inside Model X, you can also lock and unlock the vehicle by touching the icon on the touchscreen's status bar or by using the door controls that are available when you touch **Controls > Doors**.

Using the Key

To quickly familiarize yourself with the key, think of the key as a miniature version of Model X, with the Tesla badge representing the front. The key has three buttons on the top that feel like softer areas on the surface, and a metal button on each side representing the falcon wing doors.

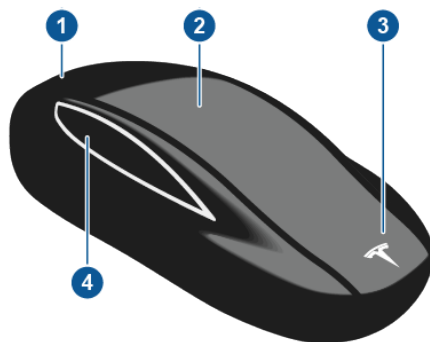

1. Trunk

- Double-click to open the rear trunk.
- If equipped with a powered liftgate, double-click to close the rear trunk. You can also single-click to stop the liftgate when it is moving.
- Hold the button down for one to two seconds to open the charge port door.

2. Lock/Unlock All

- Single-click to lock all doors and rear trunk. Hazard warning lights flash once.

Note: If a door or the rear trunk is open, hazard warning lights flash three times and doors do not lock. To enable a single-click to both close all doors (and rear trunk) and lock them, touch **Controls > Settings > Doors & Locks > Close All with Key Fob > ON**. By default, this setting is **OFF** and when off, you must triple-click this button to close and lock all doors.



- Double-click to unlock Model X. Hazard warning lights flash twice.

Note: If Model X is equipped with the premium upgrades package and Automatic Doors is set to ON (touch **Controls** > **Settings** > **Doors & Locks** > **Automatic Doors** > **ON**), doors unlock and the driver's door opens as you approach Model X. When the driver's door is open, double-clicking opens the passenger front door.

Note: If **Door Unlock Mode** is set to **Driver**, double-clicking unlocks only the driver's door and you will need to double-click again to unlock all doors and trunks. If set to **All**, the first double-click unlocks all doors and trunks. Use the touchscreen to change this setting (touch **Controls** > **Settings** > **Doors & Locks** > **Door Unlock Mode**).

3. Front trunk (also called the "frunk")

- Double-click to open the front trunk.

4. Falcon wing doors

- Double-click to open/close the associated falcon wing door.
- Single-click to stop movement of the associated falcon wing door. Subsequently double-clicking reverses movement of the falcon wing door. For example if the door was opening, it closes, and vice versa.

Note: Falcon wing doors are designed to proactively detect obstacles that prevent the doors from moving when an obstacle is detected.

Warning: Model X falcon wing doors have several sensors to detect the presence of an object in the door's path. In most cases, when an object is detected, the door stops moving. However, the sensors are unable to detect all areas under all circumstances, particularly when closing. Therefore, you must monitor the movement of falcon wing doors to ensure the door's path of movement is free of obstacles, staying prepared at all times to proactively intervene to stop the door from contacting an object (including a person). Failure to do so can cause serious damage or bodily injury.

You do not need to point the key at Model X, but you must be within operating range (which varies depending on the strength of the key's battery).

If Model X is unable to detect the key, the touchscreen displays a message indicating that a key is not inside. Place the key where Model X can best detect it, which is below the 12V power socket (see [Key Not Inside](#) on page 48).

Radio equipment on a similar frequency can affect the key. If this happens, move the key at least one foot (30 cm) away from other electronic devices (phone, laptop, etc). If the key does not work, you may need to change its battery. If the key's battery is discharged, you can open Model X by following the unlocking procedure (see [Unlocking When the Key Doesn't Work](#) on page 11).

Caution: Remember to bring the key with you when you drive. Although you can drive Model X away from its key, you will be unable to power it back on after it powers off.

Caution: Protect the key from impact, high temperatures, and damage from liquids. Avoid contact with solvents, waxes and abrasive cleaners.

Replacing the Key Battery

The key's battery lasts for approximately a year. When the battery is low, a message displays on the instrument panel. Follow these steps to replace it:



1. With the key placed button side down on a soft surface, use a small flat-bladed tool, a fingernail, or the Tesla-provided tool* to release the bottom cover.

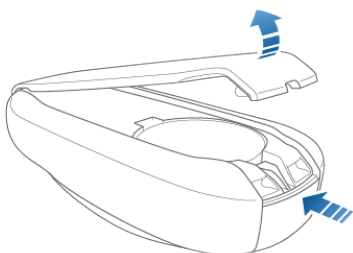

*For convenience, Tesla provides a special tool to make it easy to open the battery cover. This tool was included in the box containing your key when Model X was initially purchased.

Note: If a lanyard is attached to the key (see [Attaching a Lanyard](#) on page 6), you can release the bottom cover by placing your thumb against the "X" on the bottom cover, then firmly pulling the lanyard toward you (hence pushing the key off of its cover). You can also pry the cover off by placing a small flat-bladed tool, a fingernail, or the Tesla-provided tool against the lanyard cord.

2. Remove the battery by sliding it out at an angle.

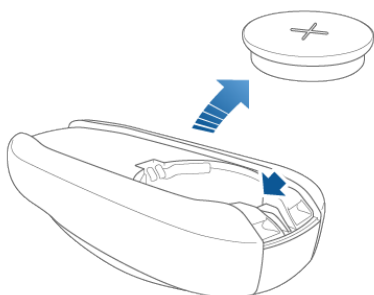

3. Insert the new battery (type CR2354) with the '+' side facing up. The battery fits snugly so you must slide it into position at an angle toward the Positive contact (the contact located near the center of the key), then press down firmly on the other side, ensuring it is held firmly in its intended position.

⚠ Caution: The battery should press against the spring on the positive contact. Do not place the battery on top of the contact and force it down vertically. Doing so may damage the contact.

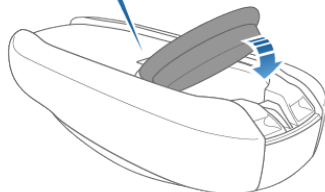
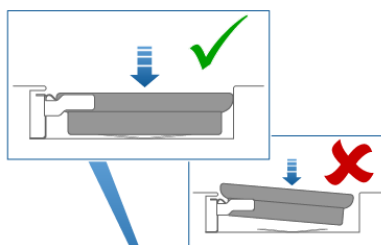

Note: Wipe the battery clean before fitting and avoid touching the battery's flat surfaces. Finger marks on the flat surfaces of the battery can reduce battery life.

4. Holding the cover at an angle, align the tabs on the widest side of the cover with the corresponding slots on the key, then press the cover firmly onto the key until it snaps into place.

Attaching a Lanyard

The Model X key supports the use of a small lanyard. To attach a lanyard, release the bottom cover as described above. Place the lanyard over the pin on the back side of the key. Re-align the cover and snap into place.

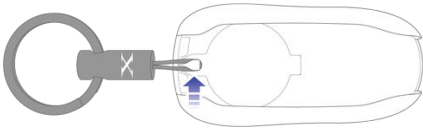

Getting More Keys

If you lose a key or require an additional one, contact Tesla. Model X can recognize up to eight keys.

When ordering a new key for Model X, take all available keys with you for reprogramming.

Opening Doors from the Interior

To open a front door, pull the interior door handle toward you.



You can also use the touchscreen to open and close doors when inside Model X. Touch **Controls > Doors**, then choose the door you want to open or close. In addition, if Model X is equipped with the premium upgrades package, when you press the brake pedal, the driver's door automatically closes.

Note: To prevent children from opening falcon wing doors using the interior handles, use the touchscreen, **Controls > Settings > Doors & Locks > Child Protection Lock**, to turn on the child-protection locks (see [Child-protection Lock](#) on page 10).

Opening and Closing Front Doors from Outside Model X

Model X doors are electrically powered. When you approach Model X carrying the key, you can specify whether just the driver's door unlocks or all doors unlock. On the touchscreen, touch **Controls > Settings > Doors & Locks > DOOR UNLOCK MODE** and choose **DRIVER** or **ALL**.

If equipped, you can also set the driver's door to unlock and open automatically upon your approach. The door partially opens (between 20° and 45° depending on obstacles detected by sensors). Touch **Controls > Settings > Doors & Locks > AUTOMATIC DOORS > ON**. To open the driver's door when this setting is on, double-click the key's lock/unlock button. To open the front passenger's door, double-click the key's lock/unlock button again.

⚠ Caution: The front doors may not fully open or close automatically when parked on a very steep hill. Never rely on Model X to fully open or close the doors for you when parked on a steep hill.

Note: Depending on date of manufacture and options chosen at time of purchase, your Model X may not be equipped with **AUTOMATIC DOORS**.



Whenever a door is open, the Door Open indicator displays on the instrument panel. The image of the Model X on the touchscreen Controls window also shows which door or trunk is open.

To close doors, you can:

- manually push them shut
- use the touchscreen (**Controls > Doors**)
- if the **CLOSE ALL WITH KEY FOB** setting is set to **OFF**, triple-click the key's lock/unlock button (this closes and locks all doors and trunks)
- if the **CLOSE ALL WITH KEY FOB** setting is set to **ON**, single-click the key's lock/unlock button (this closes and locks all doors and trunks)

You can also close an exterior front door by touching its handle when the door is already open.

Note: Powered doors stop moving if an obstacle is detected.

⚠ Warning: Before using an automatic feature to open or close a front door



(rather than doing so manually), it is important to check that the area around the door is free of obstacles (such as people and objects). You must proactively monitor the door's movement to ensure that it does not contact a person or object. Failure to do so can result in damage or serious injury.

Opening and Closing Falcon Wing Doors

Model X has electrically-powered falcon wing doors that easily open and close by pressing a button, using the key, or touching the controls on the touchscreen (**Controls > Doors**). The falcon wing doors are equipped with several sensors that detect the presence of people and objects and, if an object is detected, the door stops moving. Based on detected objects, the doors may adjust their outward and upward movement in an attempt to avoid contacting the object. For example, if an object is detected above Model X, the door's movement may extend further outward but lower, whereas if an object is detected beside the door, the door may extend outward much less.

Warning: It is important to keep your hands clear of the falcon wing door frames at all times. Proactively check the door frame area prior to closing, and monitor the movement of the door during closing to ensure that it does not come into contact with a person or object. Failure to do so can result in damage or serious injury.

Warning: Before opening or closing a falcon wing door, it is important to check that the area around the door is free of obstacles (people and objects). Although the doors have many sensors, it can not detect all objects at all times, particularly when moving. At any given moment, there may be areas near the door that are not in the detection zone. Therefore, when opening or closing a falcon wing door, you and your passengers must stand away from the door as it is moving, while proactively monitoring the door's movement and being prepared to take corrective action at any time. To stop a door from moving, single-click the falcon wing door button on the key, press the switch on the door or door pillar, or touch the button on the touchscreen.

To open a falcon wing door from outside Model X, press the door handle or press the falcon wing door button on the key (see [Using the Key](#) on page 4).

To open a falcon wing door from inside Model X, use the switch located on the door pillar, or touch the door controls on the touchscreen (**Controls > Doors**):



Note: If Model X is locked, using the switch (illustrated above) the first time unlocks the associated door. Pulling it a second time opens it.

To close a falcon wing door, press the button located on the inside of the door. You can also use the key (see [Using the Key](#) on page 4), use the switch on the door pillar (illustrated above), or touch the door controls on the touchscreen (**Controls > Doors**):

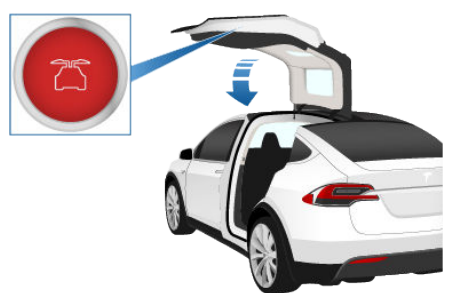

Note: To prevent children from opening falcon wing doors using the interior switch, turn on child-protection locks using the touchscreen (**Controls > Settings > Doors & Locks > CHILD-PROTECTION LOCK**). See [Child-protection Lock](#) on page 10.



Note: You can configure Model X to open the falcon wing doors to a lower height setting by using the touchscreen (**Controls > Settings > Doors & Locks > FALCON DOOR HEIGHT**).

Note: If a falcon wing door detects an obstacle while closing, it reverses a few inches before it stops moving.

Warning: Whenever a front door is partially open (approximately 20°) as you are opening or closing the associated falcon wing door, you **MUST** keep your hands (or any object) away from the opening edge of the front door. When a falcon wing door passes by a partially opened front door, the distance between the two doors is very narrow. Objects, such as hands or fingers, placed in this area, are not detected by sensors and can therefore become pinched between the doors. To avoid bodily injury, it is a good practice to keep your hands away from the front door whenever you are opening or closing a falcon wing door.

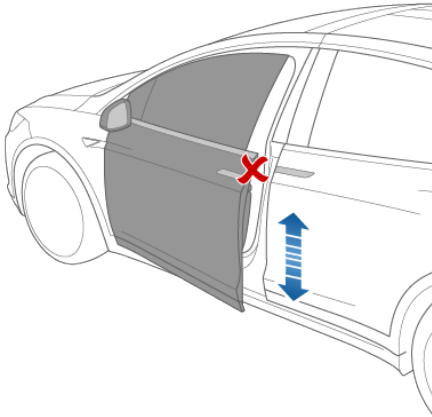

Warning: When opening or closing a falcon wing door, it is important to proactively monitor the movement of the door to ensure that it does not come into contact with a person or object. Failure to do so can cause serious damage or injury.

Caution: Remove accumulation of snow or ice before opening a falcon wing door. Snow can get inside Model X and ice can prevent the door from opening.

Caution: In rainy weather, leaving a falcon wing open while opening the liftgate can result in rain water falling from the liftgate into the rear seating area.

Note: Falcon wing doors open only when Model X is stationary.

Obstacle Detection

A falcon wing door stops moving when one of its many sensors detects an obstacle, or when the door senses resistance because it has made contact with an object. The touchscreen displays a warning on the **Doors** tab. In these cases, provided it is appropriate to continue opening or closing the falcon wing door, you can override obstacle detection by doing any of the following:

- Pressing and holding the switch located on the door pillar.
- Touch and hold the appropriate door icon on the touchscreen.

When Model X detects a low ceiling (for example, in a garage), it opens the falcon wing doors (and trunk) to a lower height, even if no obstacle is detected. You can override this height and open the doors higher by touching the associated door icon on the touchscreen (**Controls > Doors**). Model X asks you on the touchscreen if you always want to open the doors to the higher height in this location, and saves your choice. The next time you open the falcon wing doors in this location, Model X opens them to the height you saved.

Warning: Before overriding a falcon wing door's default opening height, visually inspect the area to ensure adequate clearance between the door and the detected object.

Warning: Applying adhesive products such as wraps, stickers, rubber coating, etc. on the outside of the falcon wing doors can affect the sensors' ability to detect obstacles properly.

Calibration

If the falcon wing doors lose calibration, a message displays on the touchscreen. To calibrate the doors, first ensure that both doors have plenty of space to open and close and are clear of passengers, objects, etc. Then press and hold the **Calibrate** button until five seconds after calibration is complete. During calibration, the lower door opens all the way out (requiring extra space on the side of Model X), the upper doors move all the way down, and then the lower door closes.



Interior Locking and Unlocking

From inside Model X, you can use the touchscreen to lock or unlock doors and trunks, provided a valid key is inside the vehicle. Touch the lock icon on the touchscreen's status bar.

When you stop Model X and engage the Park gear, you can choose whether you want doors to unlock or remain locked. To do so, touch **Controls > Settings > Doors & Locks > UNLOCK ON PARK**. When set to **ON**, doors automatically unlock when you engage the Park gear.

You can also unlock doors by pressing the Park button on the end of the gear selector a second time (i.e., after pressing it one time to engage the Park gear).

Note: If a door or trunk is still open when you lock Model X, it locks when you close it.

Door Unlock Mode

You can choose whether you want all doors, or just the driver's door, to unlock when you approach your vehicle carrying your key. To do so, touch **Controls > Settings > Doors & Locks > DOOR UNLOCK MODE** and choose **DRIVER** or **ALL**.

Child-protection Lock

Model X has child-protection locks on the falcon wing doors and liftgate to prevent them from being opened using interior handles. Use the touchscreen to turn child protection locks on or off. Touch **Controls > Settings > Doors & Locks > CHILD-PROTECTION LOCK**.

Note: It is recommended that you turn child-protection locks on whenever children are seated in the rear seats.

Drive-away Locking

Model X automatically locks all doors (including the trunks) whenever your driving speed exceeds 5 mph (8 km/h).

Walk-away Locking

Doors and trunks can automatically lock whenever you walk away carrying the key.

To turn this feature on or off, touch **Controls > Settings > Doors & Locks > WALK-AWAY DOOR LOCK**.

Note: If all doors are closed and you use the key to unlock Model X, walk-away locking is temporarily suspended for one minute. If you open a door within this minute, it does not re-lock until after all the doors are closed and you have walked away with the key.



Unlocking When the Key Doesn't Work

If Model X has no electrical power, the front doors open when you walk up to it, or when you press the unlock button on your key, the key's battery may be dead. If this is the case, you can still unlock and drive Model X.

To unlock Model X (and disable the security alarm), first position the key at the base of the door pillar between the front door and the falcon wing door, on the driver's side of the vehicle, as shown. Then press the front driver's door handle. If Model X doesn't unlock, try adjusting the position of the key. The key must be in the correct position. If Model X still doesn't unlock, remove the key's battery and try again. See [Replacing the Key Battery](#) on page 5.

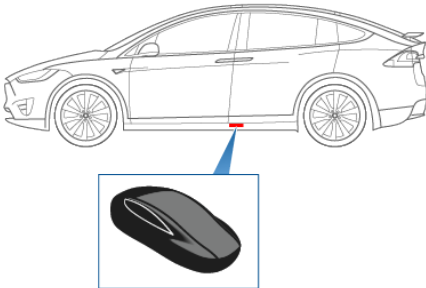

To drive Model X, place the key against the center console, immediately below the 12V power outlet, then press and hold the brake pedal to turn Model X on.

Note: Unlocking Model X using this method disables walk-away locking. You must manually re-enable walk-away locking after replacing the key's battery.

For instructions on how to replace the key's battery, see [Replacing the Key Battery](#) on page 5.

Opening Interior Doors with No Power

If Model X has no electrical power, the front doors open as usual using the interior door handles. To open the rear doors, carefully remove the speaker grille from the door and pull the mechanical release cable down and towards the front of the vehicle. After the latch is released, manually lift up the door.





Opening and Closing

Press down on a switch to lower the associated window. Window switches operate at two levels:

- To lower a window fully, press the switch all the way down and immediately release.
- To lower a window partially, press the switch gently and release when the window is where you want it.

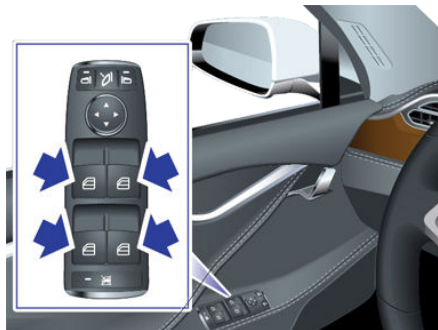

Similarly, pull a switch to raise the associated window:

- To raise a window fully, pull the switch all the way up and immediately release.
- To raise a window partially, pull the switch gently and release when the window is where you want it.

Warning: Before closing a window, it is the driver's responsibility to ensure that all occupants, especially children, do not have any body parts extended through the window's opening. Failure to do so can cause serious injury.

Locking Rear Windows

To prevent passengers from using the rear window switches, press the rear window lock switch. The switch light turns on. To unlock rear windows, press the switch again.



Warning: To ensure safety, it is recommended that you lock the rear window switches whenever children are seated in the rear seats.

Warning: Never leave children unattended in Model X.



Opening

To open the rear trunk, do one of the following:

- Touch **Controls** > **Trunk** on the touchscreen.
- Double-click the rear trunk button on the key.
- Touch the trunk button on the mobile app.
- With Model X unlocked, press the switch located under the rear trunk's exterior handle.

Note: If Passive Entry is off, you must use the key to unlock Model X before you are able to manually open the rear trunk using the switch. See [Using the Key](#) on page 4.

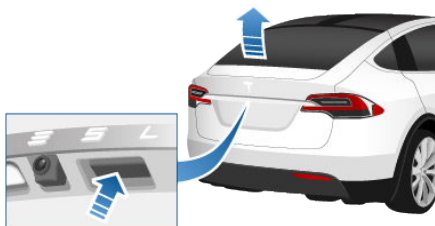

When a door or trunk/liftgate is open, the instrument panel displays the Door Open indicator light. The image of the Model X on the touchscreen **Controls** window also displays the open trunk.

To stop a powered liftgate while it is moving, single-click the rear trunk button on the key. Then, when you double-click the rear trunk button, it moves again, but in the opposite direction (provided it was not almost entirely open or closed when you stopped it). For example, if you single-click to stop the liftgate while it is opening, when you double-click, it closes.

To open the trunk from inside Model X in the unlikely situation that Model X has no power, see [Interior Emergency Trunk Release](#) on page 14.

If Model X detects a low ceiling (for example, in a garage), it opens the rear trunk (and falcon wing doors) to a lower height, even if no obstacle is detected. You can override this height manually by opening the rear trunk to a higher height. Model X asks you on the touchscreen if you always want to open the trunk to the higher height in this location, and saves your choice. The next time you open the falcon wing doors in this location, Model X opens them to the height you saved.

Warning: Before opening or closing the rear liftgate, it is important to check that the area around the liftgate is free of obstacles (people and objects). Although the powered liftgate can detect obstacles, it can not detect all objects at all times. Do not rely on the liftgate to sense an obstruction when opening or closing. You must proactively monitor the liftgate to ensure that it does not come into contact with a person or object. Failure to do so may result in damage or serious injury.

Load Limits

Secure all cargo before moving Model X, and place heavy cargo in the lower trunk compartment.

Caution: To avoid damage, never load more than 175 lbs (80 kg) on the rear load floor (above the lower trunk compartment) or more than 130 lbs (60 kg) in the lower trunk compartment. Doing so can cause damage.

Closing

To close the powered liftgate, do one of the following:

- Double-click the trunk button on the key.
- Touch **Controls** > **Trunk** on the touchscreen.
- Press the switch located on the underside of the liftgate (see [Adjusting the Opening Height](#) on page 14).

If a powered liftgate senses an obstruction when closing, it automatically opens and sounds two chimes. Remove the obstruction and try closing it again. If it cannot close the second time, powered operation is temporarily disabled. Close it manually to restore powered operation.

Note: The power closing feature is also temporarily disabled if you leave the powered liftgate open for more than an hour.



Adjusting the Opening Height

You can adjust the opening height of the powered liftgate to make it easier to reach:

1. Open the liftgate, then manually lower or raise it to the desired opening height.
2. Press and hold the button on the underside of the liftgate for two seconds until you hear a confirmation chime.

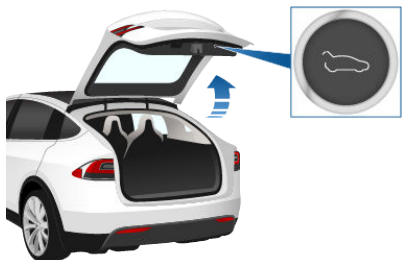

3. Confirm that you have set it to the desired height by closing the liftgate, then reopening it.

Accessing the Cargo Area

To access the cargo area inside the Model X rear trunk, push down on the ridged portion of the handle of the cargo cover and then pull up. You can then adjust the position of the cargo cover or completely remove it from Model X.



- ⚠ Caution:** Never load more than 175 lbs (80 kg) on the rear load floor (above the lower trunk compartment) or more than 130 lbs (60 kg) in the lower trunk compartment. Doing so can cause damage.

Interior Emergency Trunk Release

An illuminated mechanical release located inside the rear trunk allows you to open the rear trunk from the inside if Model X has no electrical power. This mechanical release also allows a person locked inside to get out.

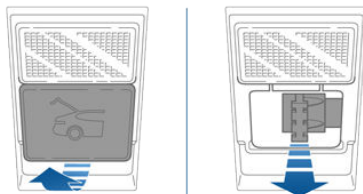

1. Remove the cover by pulling its lower edge very firmly toward you.
2. Pull the cable to release the latch.
3. Push the rear trunk open.

Note: The button glows for several hours after a brief exposure to ambient light.

- ⚠ Warning:** Do not allow children to play inside the trunk or become locked inside. An unrestrained child could suffer serious injury or death in a crash. A child could suffer heat exhaustion if trapped in the vehicle, especially without climate control on.



Opening

To open the front trunk:

1. Ensure that the area around the hood is free of obstacles.
2. Touch **Controls** > **Front Trunk** on the touchscreen, touch the front trunk button on the mobile app, or double-click the front trunk button on the key.
3. Pull the hood up.

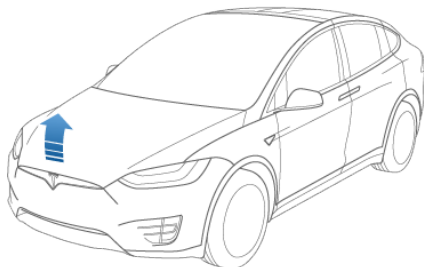

When a door or trunk/liftgate is open, the instrument panel displays the Door Open indicator light. The image of the Model X on the touchscreen **Controls** window also displays the open front trunk.

Warning: Before opening or closing the hood, it is important to check that the area around the hood is free of obstacles (people and objects). Failure to do so may result in damage or serious injury.

Note: The front trunk locks whenever closed and you lock Model X using either the touchscreen or externally using the key or mobile app, you leave Model X carrying your key (if [Walk-away Locking](#) on page 10 is turned on), or when Valet mode is active (see [Valet Mode](#) on page 43).

Closing

The Model X hood is not heavy enough to latch under its own weight and applying pressure on the front edge or center of the hood can cause damage.

To properly close the hood:

1. Lower the hood until the striker touches the latches.
2. Place both hands on the front of the hood in the areas shown (in green), then press down firmly to engage the latches.

3. Carefully try to lift the front edge of the hood to ensure that it is fully closed.

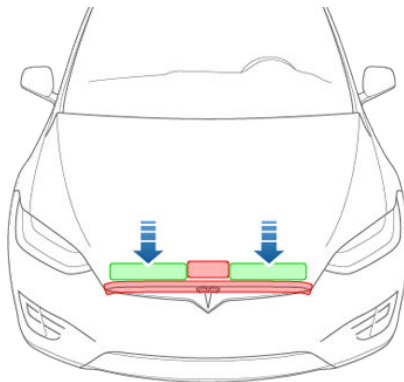

Caution: To prevent damage:

- Apply pressure only to the green areas shown. Applying pressure to the red areas can cause damage.
- Do not close the hood with one hand. Doing so applies concentrated force in one area and can result in a dent or crease.
- Do not apply pressure to the front edge of the hood. Doing so can crease the edge.
- Do not slam or drop the hood.



Warning: Before driving, you must ensure that the hood is securely latched in the fully closed position by carefully trying to lift the front edge of the hood upward and confirming there is no movement.

Interior Emergency Release

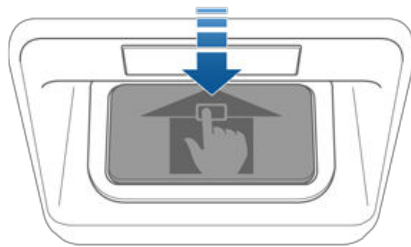

An illuminated interior release button inside the front trunk allows a person locked inside to get out.



Press the interior release button to open the front trunk, then push up on the hood.



Note: The interior release button glows following a brief exposure to ambient light.

-  **Warning:** People should never climb inside the front trunk. Never shut the front trunk when a person is inside.
-  **Warning:** Care should be taken to ensure that objects inside the front trunk do not bump against the release button, causing the trunk to accidentally open.



Opening and Closing

To open the glove box, press the switch located on the side of the touchscreen. If you leave the glove box open for five minutes, its light automatically turns off.

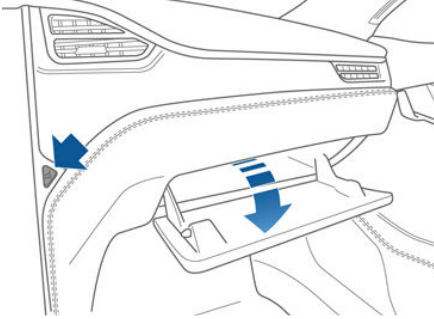

Note: The glove box locks whenever Model X is locked externally, using the key or walk-away locking. It also locks when Model X is in Valet mode (see [Valet Mode](#) on page 43). It does not lock when Model X is locked using the touchscreen.

Warning: When driving, keep the glove box closed to prevent injury to a passenger if a collision or sudden stop occurs.



Opening and Closing

To expose a front cup holder, slide back the armrest.

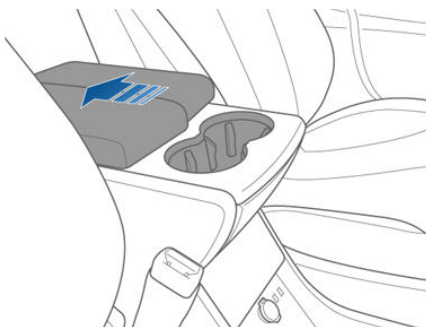

To expose rear cup holders (if available on your vehicle), press and release the cup holder face plate located at the back of the center console.

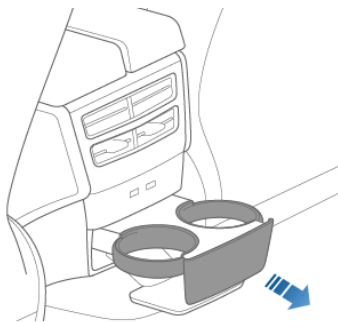



The sun visors in Model X are held in place by magnets. To protect occupants from sunlight coming through the windshield, release the sun visor from the pillar and pivot it toward the rear view mirror until the magnet snaps into place. While held in place by the magnet, you can adjust the sun visor and lower the extender to provide maximum shade.

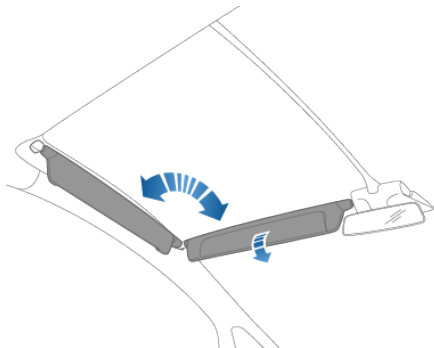

To expose the vanity mirror, lower the visor extender then lower the mirror cover. While the cover is lowered, the mirror is exposed and lights are illuminated.

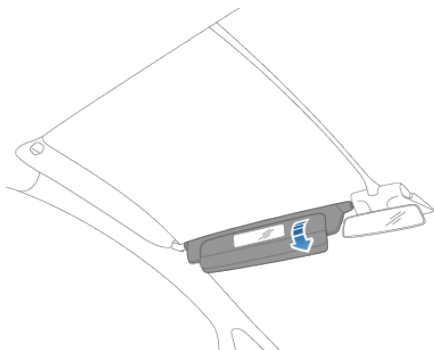

To protect front seat occupants from sunlight coming through the side window, lower the sun visor from the pillar then lower the visor extender.



Correct Driving Position

The seat, head restraint, seat belt and airbags work together to maximize your safety. Using these correctly ensures greater protection.



Position the seat so you can wear the seat belt correctly, while being as far away from the front airbag as possible:

1. Sit upright with both feet on the floor and the seat back reclined no more than 30 degrees.
2. Make sure you can easily reach the pedals and that your arms are slightly bent when holding the steering wheel. Your chest should be at least 10 inches (25 cm) from the center of the airbag cover.
3. Place the shoulder section of the seat belt mid-way between your neck and your shoulder. Fit the lap section of the belt tightly across your hips, not across your stomach.

Adjusting the Driver's Seat

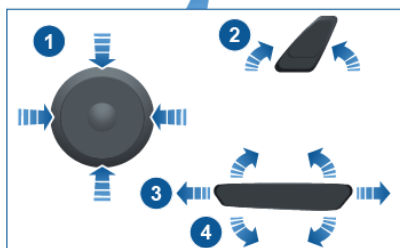
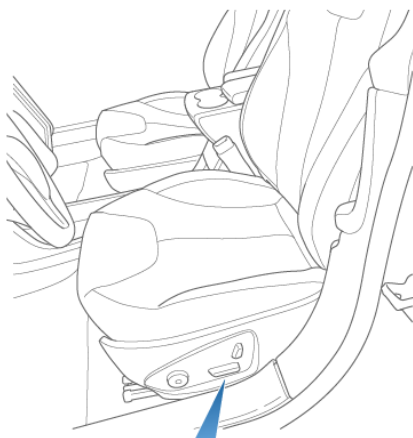

1. Adjust lumbar support.

Note: This button is also used to moved the head support up or down (see [Head Supports/Restraints](#) on page 25). When you touch this button, the touchscreen displays a popup with an image of the seat. If the lumbar area on the image is not highlighted in blue, touch the lumbar area on the image to specify that you want to adjust lumbar support. The selection you choose is retained until you manually change it.

2. Adjust backrest.
3. Move seat forward/backward.
4. Adjust the seat's height and tilt angle.

Warning: Before adjusting a front seat, check that the area around the seat is free of obstacles (people and objects).

Warning: Do not adjust seats while driving. Doing so increases the risk of a collision.

Warning: Riding in a moving vehicle with the seat back reclined can result in



serious injuries in a collision, as you could slide under the lap belt or be propelled into the seat belt. Ensure your seat back is reclined no more than 30 degrees when the vehicle is moving.

Adjusting Second Row Monopost Seats

A Model X equipped with monopost seats can accommodate up to three passengers in the second row, depending on the option chosen at time of purchase. There are two ways to adjust the position of these seats:

- Touch **Controls > Seats** on the touchscreen. Press and hold the icon on the touchscreen to adjust the associated seat. White icons indicate that the seat can be moved in that direction; gray icons indicate that the seat cannot be moved any farther in that direction.

Note: If necessary, the front seats may move forward slightly to accommodate the forward movement of the monopost seats.

- Use the manual adjustments illustrated below. In addition to moving a seat forward/rearward, the manual seat adjustments allow you to adjust the backrest. Although the control on the outboard seats is L-shaped, and the control on the middle seat is circular, they both provide the same functions.

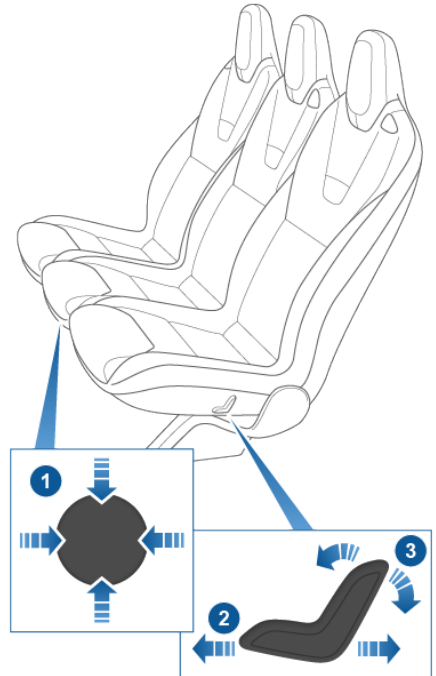



1. Move seat forward/backward (up/down on the control) and adjust the backrest (left/right on the control).
2. Move seat forward/backward.
3. Adjust backrest.

Note: The backrest locks into position when you release the lever. If a backrest is not locked into position when a driving gear is engaged, the instrument panel displays an alert for the unlocked backrest. Adjust the backrest again, ensuring it locks into position.

Warning: Riding in a moving vehicle with the seat back reclined can result in serious injuries in a collision, as you could slide under the lap belt or be propelled into the seat belt. Ensure the backs of occupied seats are reclined no more than 30 degrees when the vehicle is moving.

Adjusting Second Row Bench Seats

If your Model X is equipped with two rows of seats, the second row bench seats can accommodate up to three passengers. Use the mechanical adjustment lever located at the side of each outboard seating position to fold or recline the seatbacks. The bench seat is split 60/40 so the adjustment lever on the left side moves the seatbacks for both the left and center seats (whereas the lever on the right moves the rightmost seatback only). While pulling and holding the lever, move the seatback to the desired position, and then release the lever. When returning a seatback to its upright position, push and pull to ensure it is securely latched into position.





If your Model X is equipped with three rows of seats, in addition to adjusting the seatbacks as described above, you can use the mechanical lever located beneath each outboard seating position to move the second row bench seats forward or rearward. The lever on the left side moves the seat for the left and center seats, and the lever on the right moves only the seat on the right, because of the 60/40 split of the bench seats. Pull and hold the lever to move the seat forward or rearward to the desired position, and then release the lever.

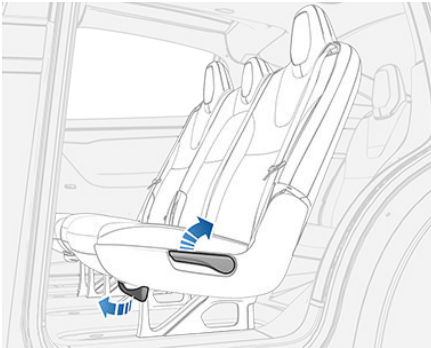

Note: You can adjust bench seats using only the mechanical levers. (You cannot adjust bench seats on the touchscreen.) A bench seat in five-seat vehicles cannot be moved forward or rearward; a bench seat in seven-seat vehicles can be moved forward and rearward.

Warning: Riding in a moving vehicle with the seat back reclined can result in serious injuries in a collision, as you could slide under the lap belt or be propelled into the seat belt. Ensure the backs of occupied seats are reclined no more than 30 degrees when the vehicle is moving.

Folding Second Row Bench Seats

You can fold Model X second row bench seats flat. Before you fold second row seats flat, remove items from the seats and the rear footwell. To enable the second row seatbacks to fold completely flat, you may need to move the front seats forward.

To fold second row bench seats flat, simply pull up on the mechanical lever located on the side of each outboard seat, and fold the seatback flat. The adjustment lever on the left side folds the seatbacks for both the left and center seats, whereas the lever on the right folds the rightmost seatback only.

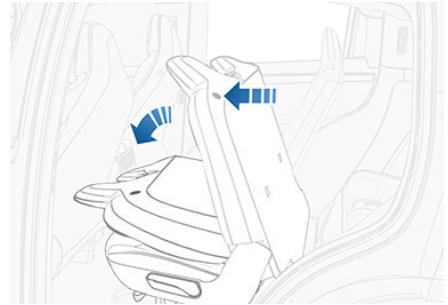

Accessing Third Row Seats

Accessing third row seats when monopost seats are installed in the second row:

The Easy Entry button located on the backrest of each second row outboard monopost seat makes it easy for passengers to enter and exit the third row seating positions (if equipped). When the **Easy Entry** setting is enabled (on by default), you can tilt and move the associated outboard seat fully forward and move the center seat forward with a single press of the Easy Entry button. If **Easy Entry** is disabled (recommended if a child seat is installed in the second row), you must hold the Easy Entry button to move the seats. Touch **Controls** > **Settings** > **Vehicle** > **Easy Entry** > **OFF** to disable single press Easy Entry. After you use Easy Entry to access third row monopost seats, simply press the Easy Entry button on the backrest of either outboard seat to move the seats back to their seating position.

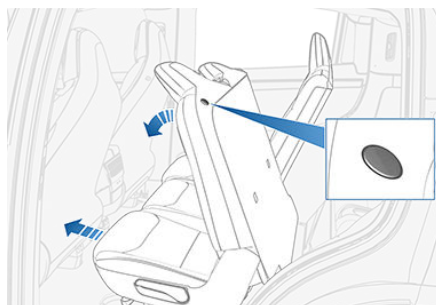
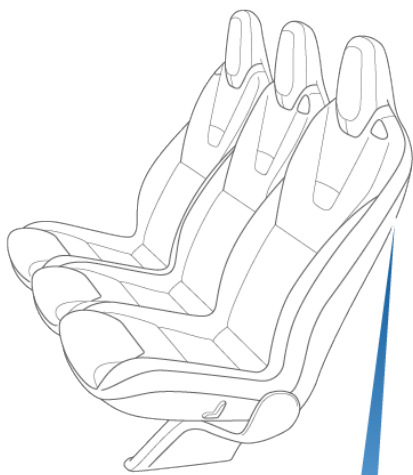

In some situations, such as when you are parked on an incline or when the seat trim affects the movement of the bench seats, after you press the Easy Entry button, the bench seats might not move forward completely, and you may need to push the seats forward gently until they reach the end of the track.

If a front row seat is positioned such that the second row monopost or bench seat will collide with it during an easy entry operation, it automatically moves forward just enough to accommodate the forward position of the second row seat.

Note: Forward movement of second row seats cancels if an occupant adjusts a second row seat while it is moving.

Note: When an outboard seat tilts forward for easy entry, its backrest resets to the neutral position and may need to be re-adjusted.

Warning: Do not rely on Model X to recognize or accommodate occupants seated in the vehicle while using the Easy Entry feature. Use Easy Entry only when seats are unoccupied.

Accessing third row seats when bench seats are installed in the second row:

The Easy Entry button located on the backrest of each second row outboard bench seat makes it easy for passengers to enter and exit the third row seating positions (if equipped). Press and release the Easy Entry button on the left outboard seat to tilt and move the combined left and center seats forward. Press and release the Easy Entry button on the right outboard seat to tilt and move the right seat forward. After you use Easy Entry to access the third row seats, push the bench seats back to their seating position, ensuring the seats are securely latched into position by pushing and pulling on them.

Note: When bench seats are installed in the second row, you access the third row seats simply by pressing and releasing the Easy Entry button.

Folding Third Row Seats

If Model X is equipped with third row seats, remove items from the seats and the rear footwell before folding. To allow the third row seat backs to fold completely flat, you may need to move the second row seats forward.

To fold a third row seat, press the button located in the top outside corner of the seat. The button has two detents.

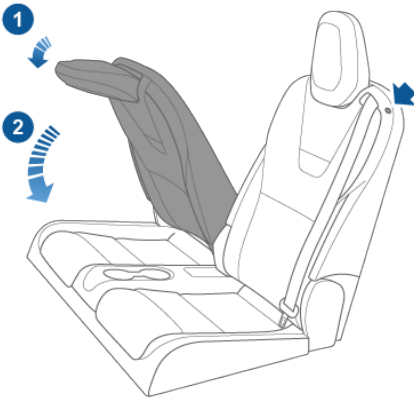

1. Fold head restraint forward.
2. Fold seat forward.

Note: If necessary, the second row seat may move forward slightly to accommodate the forward position of the third row seat.

Note: To raise the seats, hold the button on the top outside corner of the seat then pull the seat back upward until it latches into place. To confirm the seat back is locked in the upright position, try pulling it forward.

Warning: Always ensure the seat backs are locked in their upright position. Failure to do so increases the risk of injury.

Head Supports/Restraints

Use the round button on the seat to move the headrest up/down. The same button is used to adjust the seat's lumbar support (see [Adjusting the Driver's Seat](#) on page 20). Therefore, when you touch this button, the touchscreen displays a popup with an image of the seat. If the head support shown on the image is not highlighted in blue, touch this area on the image to specify that you want to adjust the head support. The selection you choose is retained until you manually change it. You can save the head support setting to your driver profile (see [Driver Profiles](#) on page 42).

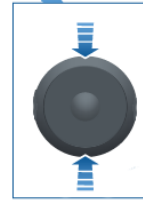
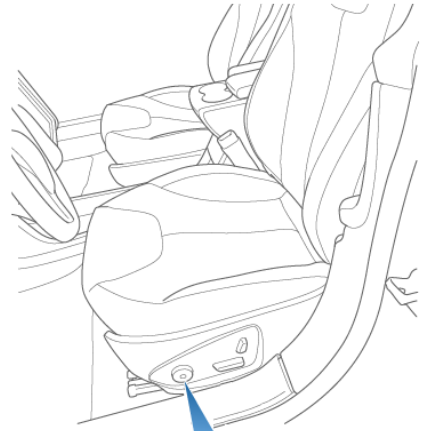

The second and third row seats have integrated non-removable head supports that can not be adjusted. However, the head supports in the third row seats can be folded down for storage (see [Folding Third Row Seats](#) on page 24).

Seat Heaters

The front seats are equipped with heating pads that operate at three levels from 3 (highest) to 1 (lowest). To operate the seat heaters, see [Climate Controls](#) on page 123.

If Model X is equipped with the optional cold weather package, you can also control seat heaters in all rear seating positions, as well as heated wipers and washer nozzles by touching **Controls > Cold Weather** (see [Controls](#) on page 116).

Warning: To avoid burns resulting from prolonged use, individuals who have peripheral neuropathy, or whose capacity to feel pain is limited because of diabetes, age, neurological injury, or some other condition, should exercise caution when using the climate control system and seat heaters.



Seat Covers

-  **Warning:** Do not use seat covers in Model X. Doing so could restrict deployment of the seat-mounted side air bags if a collision occurs. It can also reduce the accuracy of the occupant detection system.



Wearing Seat Belts

Using seat belts and child safety seats is the most effective way to protect occupants if a collision occurs. Therefore, wearing a seat belt is required by law in most jurisdictions.

Both the driver and passenger seats are equipped with three-point inertia reel seat belts. Inertia reel belts are automatically tensioned to allow occupants to move comfortably during normal driving conditions. To securely hold child safety seats, all passenger seating positions are equipped with an automatic locking retractor (ALR) that, by pulling the seat belt beyond the length needed for a typical adult occupant, locks the belt into place until the seat belt is unbuckled (see [Installing Seat Belt Retained Child Seats](#) on page 32).

The seat belt reel automatically locks to prevent movement of occupants if Model X experiences a force associated with hard acceleration, braking, cornering, or an impact in a collision.



The seat belt reminder on the instrument panel alerts you if a seat belt for an occupied seat is not fastened. If the belt remains unfastened, the reminder flashes and an intermittent chime sounds. If all occupants are buckled up and the reminder stays on, re-fasten seat belts to ensure they are correctly latched. Also remove any heavy objects (such as a briefcase) from an unoccupied seat. If the reminder light continues to stay on, contact Tesla.

To Fasten a Belt

1. Ensure correct positioning of the seat (see [Correct Driving Position](#) on page 20).
2. Draw the belt out smoothly, ensuring the belt lays flat across the pelvis, chest and mid-point of your collar bone, between the neck and shoulder.

3. Insert the latch plate into the buckle and press together until you hear a click indicating it is locked in place.

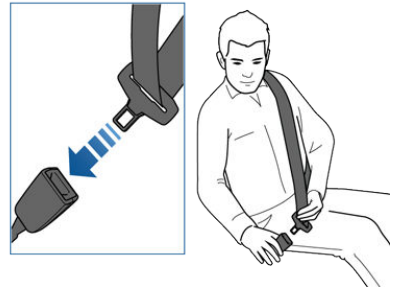

4. Pull the belt to check that it is securely fastened.
5. Pull the diagonal part of the belt toward the reel to remove excess slack.

To Adjust the Shoulder Anchor Height

Model X is equipped with an adjustable shoulder anchor for each front seat to ensure that the seat belt is positioned correctly. The seat belt should lay flat across the mid-point of your collar bone while in the correct driving position (see [Correct Driving Position](#) on page 20). Adjust the height of the shoulder anchor if the seat belt is not positioned correctly:

1. Press and hold the button on the shoulder anchor to release the locking mechanism.
2. While holding the button, move the shoulder anchor up or down as necessary so that the seat belt is positioned correctly.

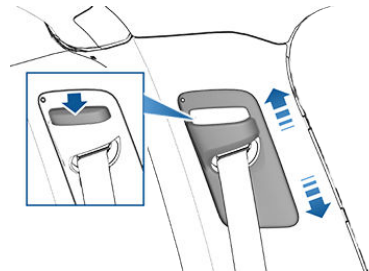

3. Release the button on the shoulder anchor so that it locks into position.
4. Without pressing the button, pull on the seat belt webbing and attempt to move the shoulder anchor downwards to check that it is locked into position.



Warning: Ensure that the seat belt is positioned correctly and that the shoulder anchor is locked into position before driving. Riding in a moving vehicle with the seat belt positioned incorrectly or with the shoulder anchor not locked into position can reduce the effectiveness of the seat belt in a collision.

To Release a Belt

Hold the belt near the buckle to prevent the belt from retracting too quickly, then press the button on the buckle. The belt retracts automatically. Ensure there is no obstruction that prevents the belt from fully retracting. The belt should not hang loose. If a seat belt does not fully retract, contact Tesla.

Wearing Seat Belts When Pregnant

Do not put the lap or shoulder sections of the seat belt over the abdominal area. Wear the lap section of the belt as low as possible across the hips, not the waist. Position the shoulder portion of the belt between the breasts and to the side of the abdomen. Consult your doctor for specific guidance.



Warning: Never place anything between you and the seat belt to cushion the impact in the event of a collision.

Seat Belt Pre-tensioners

The front seat belts are equipped with pre-tensioners that work in conjunction with the airbags in a severe frontal collision. The pre-tensioners automatically retract both the seat belt anchor and the seat belt webbing, reducing slack in both the lap and diagonal portions of the belts, resulting in reduced forward movement of the occupant.

The rear outboard seats are equipped with shoulder pre-tensioners to retract the seat belt webbing to reduce forward movement of the occupant.

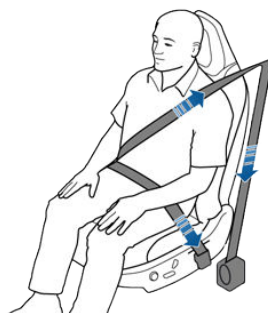

If the pre-tensioners and airbags did not activate in an impact, this does not mean they malfunctioned. It usually means that the strength or type of force needed to activate them was not present.

Warning: Once the seat belt pre-tensioners have been activated, they must be replaced. After any collision, have the airbags, seat belt pre-tensioners and any associated components checked and, if necessary, replaced.

Testing Seat Belts

To confirm that seat belts are operating correctly, perform these three simple checks on each seat belt.

1. With the seat belt fastened, give the webbing nearest the buckle a quick pull. The buckle should remain securely locked.
2. With the belt unfastened, unreel the webbing to its limit. Check that unreeling is free from snags, and visually check the webbing for wear. Allow the webbing to retract, checking that retraction is smooth and complete.













3. With the webbing half unreeled, hold the tongue plate and pull forward quickly. The mechanism should lock automatically and prevent further unreeling.



If a seat belt fails any of these tests, contact Tesla immediately.

For information about cleaning seat belts, see [Seat Belts](#) on page 167.

Seat Belt Warnings

-  **Warning:** Seat belts should be worn by all occupants at all times, even if driving for a very short distance. Failure to do so increases the risk of injury or death if a collision occurs.
-  **Warning:** Secure small children in a suitable child safety seat (see [Child Safety Seats](#) on page 30). Always follow the child safety seat manufacturer's instructions when installing.
-  **Warning:** Ensure that all seat belts are worn correctly. An improperly worn seat belt increases the risk of injury or death if a collision occurs.
-  **Warning:** Do not wear seat belts over hard, fragile or sharp items in clothing, such as pens, keys, eyeglasses, etc. The pressure from the seat belt on such items can cause injury.
-  **Warning:** Seat belts should not be worn with any part of the strap twisted.
-  **Warning:** Each seat belt assembly must be used by one occupant only. It is dangerous to put a seat belt around a child being carried on an occupant's lap.
-  **Warning:** Seat belts that have been worn in a collision must be inspected or replaced by Tesla, even if damage to the assembly is not obvious.
-  **Warning:** Seat belts that show signs of wear (such as fraying), or have been cut or damaged in any way, must be replaced by Tesla.
-  **Warning:** Avoid contaminating a seat belt's components with any chemicals, liquids, grit, dirt or cleaning products. If a seat belt fails to retract or latch into the buckle, it must be replaced immediately. Contact Tesla.
-  **Warning:** Do not make modifications or additions that can prevent a seat belt mechanism from taking up slack, or that can prevent a seat belt from being

adjusted to remove slack. A slack belt greatly reduces occupant protection.

-  **Warning:** Do not make modifications that can interfere with the operation of a seat belt, or that can cause a seat belt to become inoperable.
-  **Warning:** When seat belts are not in use, they should be fully retracted and not hanging loose. If a seat belt does not fully retract, contact Tesla.



Guidelines for Seating Children

Your Model X seat belts in all passenger seating positions are designed for adults and larger children. You must restrain infants and small children in the second and rear row seats only, and you must use a suitable child safety seat appropriate for the child's age, weight, and size.

Never use child safety seats in the front row passenger seat.

Warning: Never seat a child on a seat with an ACTIVE AIRBAG in front of it. DEATH or SERIOUS INJURY to the child can occur.

Note: If your Model X is equipped with second row monopost seats, it is recommended that you disable **Easy Entry** whenever installing a child seat in the second row (see [Accessing Third Row Seats](#) on page 23).

Refer to the following label fitted to the sun visors.

Note: The images shown below are representative only and may not be identical to the labels in your vehicle.

United States:

<p>EVEN WITH ADVANCED AIR BAGS</p> <ul style="list-style-type: none"> • Children can be killed or seriously injured by the air bag • See owner's manual for more information about air bags • The back seat is the safest place for children • Never put a rear-facing child seat in the front • Always use seat belts and child restraints 	 <p style="text-align: center;">WARNING</p>
---	---

Canada:

<p>EVEN WITH ADVANCED AIR BAGS</p> <ul style="list-style-type: none"> • Children can be killed or seriously injured by the air bag • See owner's manual for more information about air bags • The back seat is the safest place for children • Never put a rear-facing child seat in the front • Always use seat belts and child restraints • Sit as far back as possible from the air bag 	<p>MÊME AVEC DES COUSSINS GONFLABLES ÉVOLUÉS</p> <ul style="list-style-type: none"> • Un coussin gonflable présente un danger de mort ou de blessure grave pour les enfants • Pour plus d'informations sur les coussins gonflables, voir le manuel de l'utilisateur • Le siège arrière est l'endroit le plus sûr pour les enfants • Ne jamais placer à l'avant un siège pour enfants faisant face à l'avant • Utilisez toujours les ceintures de sécurité et les dispositifs de retenue pour enfants • Assseyez-vous le plus loin possible du coussin gonflable 	 <p style="text-align: center;">WARNING AVERTISSEMENT</p>
---	--	---

Mexico:

<p>AÚN CON BOLSAS DE AIRE AVANZADAS</p> <ul style="list-style-type: none"> • Los niños pueden morir o resultar seriamente lesionados por la bolsa de aire. • Consulte el manual del propietario para obtener más información sobre las bolsas de aire. • El asiento trasero es el lugar más seguro para los niños. • Nunca ponga un asiento para niño con vista hacia atrás en un asiento delantero. • Siempre utilice los cinturones de seguridad y sistemas de restricción para niños. 	 <p style="text-align: center;">ADVERTENCIA</p>
--	---



Choosing a Child Safety Seat

All children age 12 and under should ride in the second and rear row seats. Always use a child safety seat suitable for a young child's age and weight.

	Infants	Toddlers	Young children
Age	Birth to 1 year*	Over 1 year*	4 years and older, and less than 57 in. (145 cm) tall
Weight	Up to at least 20 lbs (9 kg)*	Over 20 lbs (9 kg) (minimum) and up to 40 lbs (18 kg)*	Over 40 lbs (18 kg)
Type of child safety seat	Rear facing (or convertible)	Forward facing (or convertible)*	Seat belt retained booster seat
Seat position	Rear facing only*	Forward facing*	Forward facing
Recommended attachment method	If combined weight of child and safety seat is up to 65 lbs (29 kg), attach using either LATCH** (lower anchor only) or the seat belt only.*** If combined weight of child and safety seat is over 65 lbs (29 kg), attach using the seat belt only.***	If combined weight of child and safety seat is up to 65 lbs (29 kg), attach using either LATCH** (both lower anchors and top tether anchor), or the seat belt and upper tether strap.*** If combined weight of child and safety seat is over 65 lbs (29 kg), attach using the seat belt and upper tether strap.***	Attach booster seats using the seat belt only.
<p>* Many child safety seats currently available allow children to ride rear-facing using the child safety seat's integrated 5-point harness for a longer period of time BASED UPON SPECIFIC HEIGHT AND WEIGHT LIMITS. Keep your child in a rear facing seat for as long as possible. CHECK THE CHILD SAFETY SEAT MANUFACTURER'S INSTRUCTIONS AND CAREFULLY FOLLOW ALL INSTRUCTIONS</p> <p>** LATCH - Lower Anchors and Tethers for Children. In Canada, this is also called Lower Universal Anchorage System (LUAS), or CANFIX.</p> <p>*** Subject to instructions provided by the child safety seat manufacturer.</p>			

Warning: Laws that govern how and where children should be carried when traveling in a vehicle are subject to change. It is the driver's responsibility to keep up to date on, and comply with, all current regulations in the region(s) where Model X is driven. To check the child passenger safety laws for states in the U.S., go to: http://www.ghsa.org/html/stateinfo/laws/childsafety_laws.html.



Seating Larger Children

If a child is too large to fit into a child safety seat, but too small to safely fit into the standard seat belts, use a booster seat appropriate for the child's age and size. Carefully follow the manufacturer's instructions to secure the booster seat.

Installing Child Safety Seats

There are two general methods used to install child safety seats:

- Seat belt retained - these seats are secured using the vehicle's seat belts (see [Installing Seat Belt Retained Child Seats](#) on page 32).
- LATCH retained - these seats can attach to anchor bars built into the vehicle's rear seats (see [Installing LATCH Child Seats](#) on page 32).

Check the child safety seat manufacturer's instructions and the table at [Child Safety Seats](#) on page 30 to determine which installation method to use. Some child safety seats can be installed using either method. Always follow the child safety seat manufacturer's instructions.

Installing Seat Belt Retained Child Seats

First, make sure that the child safety seat is appropriate for the weight, height, and age of the child.

Avoid dressing the child in bulky clothing and do not place any objects between the child and the restraint system.

Adjust harnesses for every child, every trip.

To securely hold child safety seats, all passenger seating positions are equipped with an automatic locking retractor (ALR) that, by pulling the seat belt beyond the length needed for a typical adult occupant, locks the belt into place until the seat belt is unbuckled and the webbing is fully retracted. The ALR mechanism operates as a ratchet, winding in slack and preventing the seat belt from extending any further until it has been completely rewound. When installing a child safety seat, engage the belt's automatic locking retractor by pulling the seat belt webbing until it is fully extended. The ALR system engages only when the seat belt is at its maximum extension point.

Note: An automatic locking retractor disengages only when the seat belt is unbuckled and fully retracted. The belt can then be worn as a normal belt, sliding freely in and out and locking tight only in an emergency. Once disengaged, the belt must be fully extended to re-engage the locking mechanism whenever you install a child safety seat.

Always follow the detailed instructions provided by the child safety seat manufacturer. General guidelines are provided below.

1. Place the child safety seat in Model X, and fully extend the seat belt. Route and buckle the seat belt in accordance with the child safety seat manufacturer's instructions.



2. Allow the seat belt to retract, and remove all slack in the seat belt while firmly pushing the child safety seat into the Model X seat.
3. If the seat belt retained child safety seat has an upper tether, attach it to the back of the seat (see [Attaching Upper Tether Straps](#) on page 35).

Installing LATCH Child Seats

Lower LATCH anchors are provided in the second row outboard seats and in both rear row seats. The anchors are located between the seat's back rest and rear cushion. The exact location of each anchor is identified by a child safety seat identification button, illustrated below. The button is located on the seat back, directly above its associated anchor.

Monopost Seats:



Bench Seats:

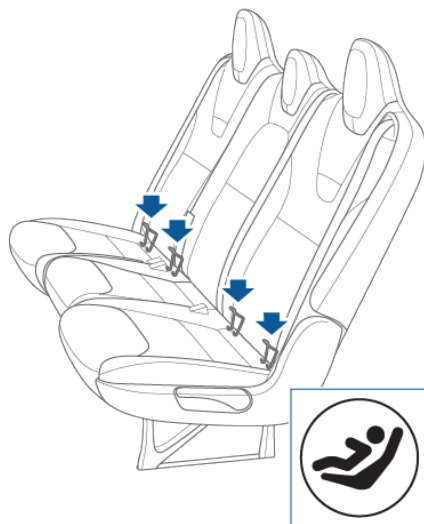
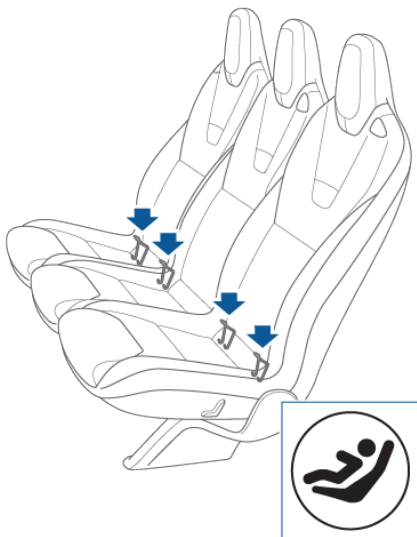

In the second row, install LATCH child safety seats in the outboard seating positions only. Use only a seat belt retained seat in the center position.

Note: If Model X is equipped with two seats in the second row, both seats support the use of LATCH child safety seats.

Monopost Seats:

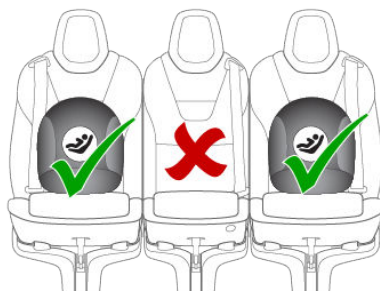



Bench Seats:

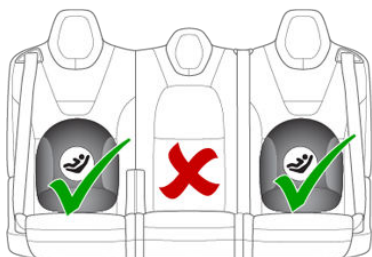

In the third row (if equipped), you can install LATCH child safety seats in both seating locations.

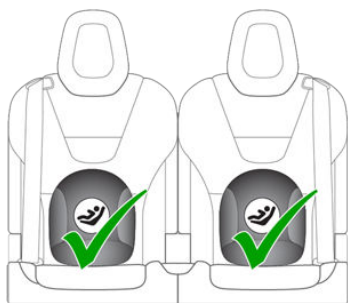

To install a LATCH child safety seat, slide the safety seat latches onto the anchor bars until they click into place. Carefully read and follow the instructions provided by the child safety seat manufacturer.

Monopost Seats:

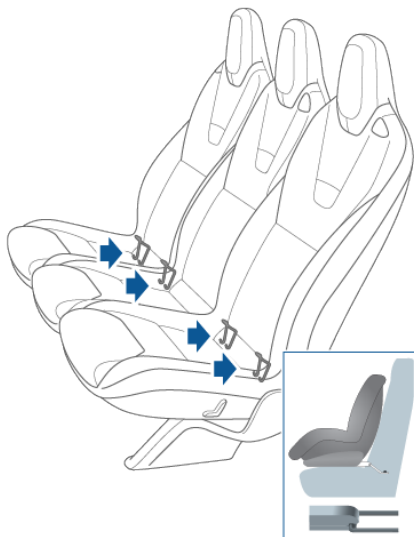

Bench Seats:

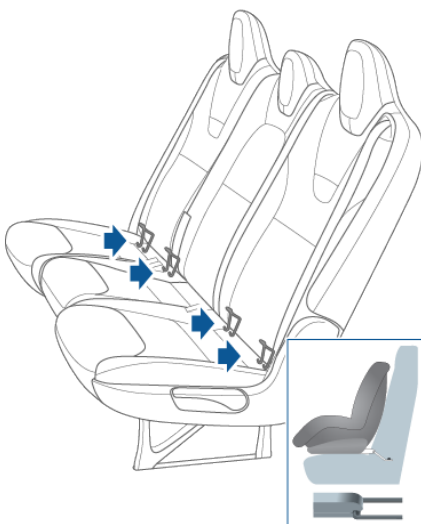

Once installed, test the security of the installation before seating a child. Attempt to twist the child safety seat from side to side and try to pull it away from the seat, then check to ensure the anchors remain securely in place.



Note: Lower LATCH anchors should not be used with child seats or booster seats that have an integrated safety belt in situations where the combined weight of the child plus the child restraint is more than 65 lbs (29 kg). In these situations, use the safety belt instead.

Attaching Upper Tether Straps

If an upper tether strap is provided, attach its hook to the anchor point located on the back of the second and third row seats.

Note: The location of anchor points may not be readily visible but can be found by identifying a slice in the seat's material.

Warning: Tighten upper tether straps according to the instructions provided by the manufacturer of the child safety seat.

Warning: USE ONLY SEAT BELT RETAINED CHILD SAFETY SEATS IN THE CENTER SEATING POSITION.

For dual-strap tethers, position a strap on each side of the head restraint.

Dual Straps - Second Row Monopost Seats:

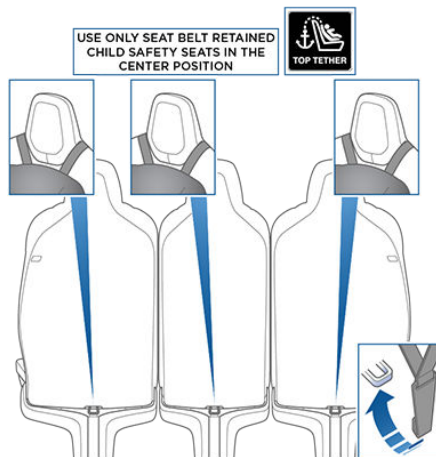

Dual Straps - Second Row Bench Seats:

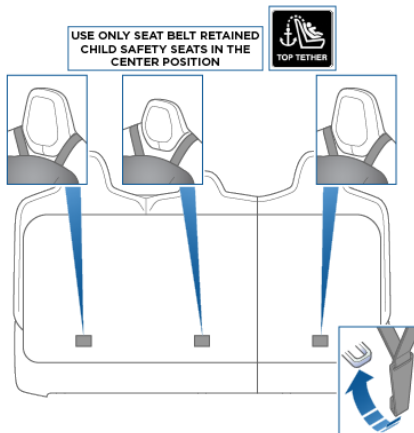

Dual Straps - Third Row Seats:

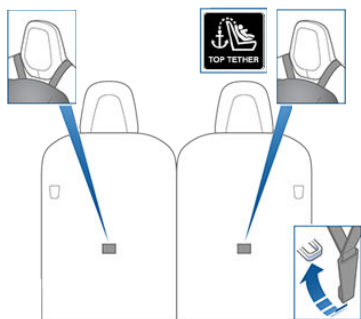

For single-strap tethers, position the strap in the outboard seating positions over the outside-facing side of the head restraint (i.e. same side of the head restraint as the seat belt retraction mechanism). In the center seating position (if equipped), center and position the strap over the top of the head restraint.

Single Strap - Second Row Monopost Seats:

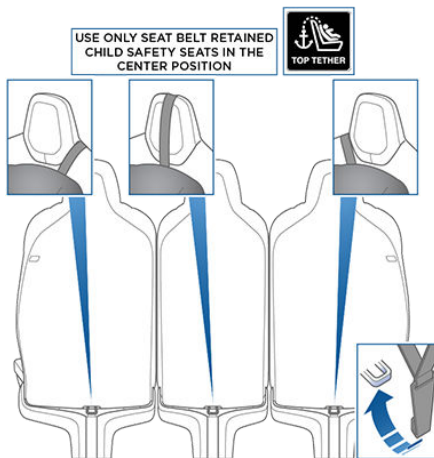

Single Strap - Second Row Bench Seats:

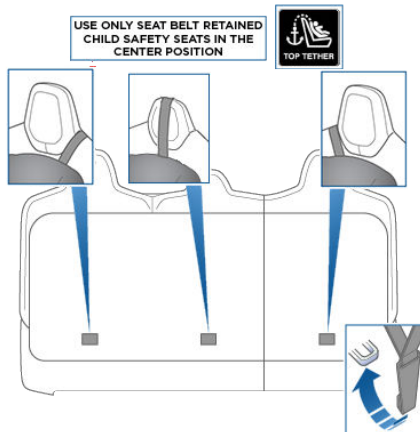



Single Strap - Third Row Seats

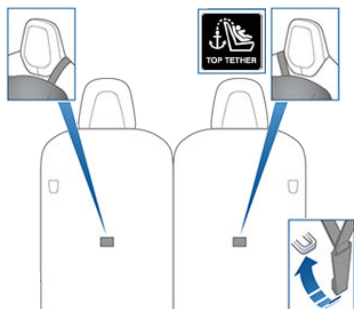

Note: If Model X is equipped with the optional six seat interior, a center seating position is not available in the second row.

Testing a Child Safety Seat

Before seating a child, always make sure the child safety seat is not loose:

1. Hold the child safety seat by the belt path and try to slide the safety seat from side to side and front to back.
2. If the seat moves more than one inch (2.5 cm), it is too loose. Tighten the belt or reconnect the LATCH retained child safety seat.
3. If you are unable to reduce slack, try a different seat location or try another child safety seat.

Child Safety Seat Warnings

- Warning:** Extreme hazard! Do not seat a child on the front passenger seat even if you are using a child safety seat. This seat has an airbag in front of it. Although this airbag is disabled when Model X detects a lightweight passenger, do not rely on technology to protect your child.
- Warning:** Child restraint systems are designed to be secured in vehicle seats by lap belts or the lap belt portion of a lap-shoulder belt. Children could be endangered in a crash if their child restraints are not properly secured in the vehicle.
- Warning:** According to collision statistics, children are safer when properly restrained in the rear seating positions than in the front seating positions.

- Warning:** Do not use a forward facing child safety seat until your child weighs over 20 lbs (9 kg) and can sit independently. Up to the age of two, a child's spine and neck are not sufficiently developed to avoid injury in a frontal impact.
- Warning:** Do not allow a baby or infant to be held on a lap. All children should be restrained in an appropriate child safety seat at all times.
- Warning:** To ensure children are safely seated, follow all instructions provided in this document and by the manufacturer of the child safety seat.
- Warning:** Children should ride in a rear facing child safety seat using the seat's integrated 5-point harness for as long as possible.
- Warning:** Do not use seat belt extenders on a seat belt that is being used to install a child safety seat or booster seat.
- Warning:** When seating larger children, make sure the child's head is supported and the child's seat belt is properly adjusted and fastened. The shoulder portion of the belt must be away from the face and neck, and the lap portion must not be over the stomach.
- Warning:** Never attach two child safety seats to one anchor point. In a collision, one anchor point may be incapable of securing both seats.
- Warning:** Child restraint anchors are designed to withstand only those loads imposed by correctly fitted child restraints. Under no circumstances are they to be used for adult seat belts, harnesses, or for attaching other items or equipment to the vehicle.
- Warning:** Always check harnesses and tether straps for damage and wear.
- Warning:** Never leave a child unattended, even if the child is secured in a child safety seat.
- Warning:** Never use a child safety seat that has been involved in a collision. Have the seat inspected or replaced as described in the child safety seat manufacturer's instructions.



Location of Airbags

Airbags are located in the approximate areas shown here. Airbag warning information is printed on the sun visors.

Model X is equipped with an airbag and lap/shoulder belt at both front outboard seating positions. The airbag is a supplemental restraint at those seating positions. All occupants, including the driver, should always wear their seat belts whether or not an airbag is also provided at their seating position to minimize the risk of severe injury or death in the event of a crash.

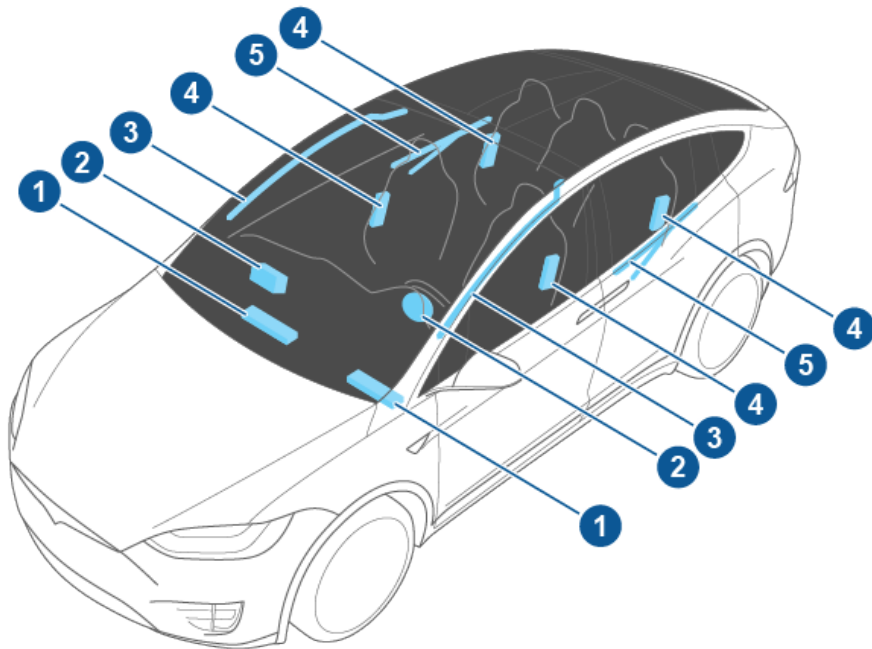

1. Knee airbags
2. Front airbags
3. Curtain airbags
4. Seat-mounted side airbags
5. Door-mounted airbags



How the Airbags Work

Airbags inflate when sensors detect an impact that exceeds deployment thresholds. These thresholds are designed to predict the severity of a crash in time for the airbags to help protect the vehicle's occupants.

Airbags inflate instantly with considerable force accompanied by a loud noise. The inflated bag, together with the seat belts, limits movement of occupants to reduce the risk of injury.

Front airbags are not ordinarily designed to inflate in rear collisions, rollovers, minor front or side collisions, heavy braking, or driving over bumps and potholes. Therefore, significant superficial damage can occur to the vehicle without the airbags inflating or, conversely, a relatively small amount of structural damage can cause airbags to inflate.

If you are planning to modify your vehicle for a person with disabilities in a way that may affect the airbag system, contact Tesla.

Types of Airbags

Model X has the following types of airbags:

- **Advanced front airbags:** The front airbags are designed to reduce airbag related injuries if children or small adults are riding in the front seats. On the driver's side, the front airbag works with a seat position sensor that adjusts the inflation level based on the seating position of the occupant. On the passenger's side, the airbag responds to a sensing system in the seat that determines whether or not the passenger side front airbag inflates, and optimizes the inflation level based on the weight of the occupant. Follow all warnings related to seating a child on the front passenger seat.
- **Knee airbags:** Knee airbags and the front airbags work together. The knee airbags limit the forward motion of the front seat occupants by restricting leg movement, thereby positioning the occupants so that the front airbags work more effectively.
- **Seat-mounted side airbags:** There is a seat-mounted side airbag in each of the front driver, front passenger and second row outboard seats. Seat-mounted side airbags protect the thorax region of the torso and the pelvis. They inflate in the event of severe side impact or severe offset frontal impact. The seat-mounted side airbags on both the impacted and non-impacted side of the vehicle will inflate. When the backrest of an outboard seat is fully folded in the forward position, its associated side airbag does not inflate.
- **Curtain airbags:** There is a curtain airbag on each side of Model X in the front roof-rail. Curtain airbags help protect the head and typically inflate in the event of a severe side impact, a severe offset frontal impact, or if the vehicle rolls over. Curtain airbags on both the impacted and non-impacted side of the vehicle will inflate.
- **Door-mounted airbags:** There is an airbag on each side of Model X mounted in the trim on the falcon wing doors. These are the same as the curtain airbags in that they help protect the head and typically inflate in the event of a severe side impact, a severe offset frontal impact, or if the vehicle rolls over. The door-mounted airbags on both the impacted and non-impacted side of the vehicle will inflate.

Passenger Front Airbag

Model X has an occupancy sensor in the front passenger seat that controls the status of the airbags based on the weight of the occupant. If the passenger airbag is OFF, it will not inflate when a collision occurs, and the passenger airbag off indicator displays in the top right corner of the touchscreen. If the passenger airbag is ON, it will inflate when a collision occurs, and its status does not display in the top right corner of the touchscreen.

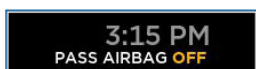

Note: The occupancy sensor system meets the regulatory requirement of FMVSS 208 and automatically detects when inflating the passenger front airbags would be unnecessary or potentially harmful.

Weight in front passenger seat	Passenger airbag status
Empty	OFF
Up to 20 lbs/9 kg	OFF
20-100 lbs/9-45 kg*	OFF* or ON**
Over 100 lbs/45 kg	ON**

*Values are approximate. A weight detected near the threshold can cause the airbag status to occasionally turn on and off depending on seating position and physique.

**The absence of the passenger airbag off indicator in the top right corner of the touchscreen indicates that the passenger airbag is ON and will inflate in the event of a collision.

Note: It takes approximately six seconds after you power on Model X for the occupancy sensor to report accurate status of the front passenger airbag. As a result, when you first power on Model X, even in situations when it should be OFF because the passenger seat is either empty or carrying a weight of 20 lbs (9 kg) or less, the touchscreen can take up to six seconds to display the passenger airbag off

indicator. If it fails to do so, contact Tesla service immediately and seat passengers in the rear seating positions only.

If the passenger airbag is permanently off, even when the seat is empty, contact Tesla immediately.

To make sure the sensing system can correctly detect occupancy status, eliminate the following:

- Objects lodged under the seat.
- Heavy objects sitting on the seat (briefcase, large purse).
- Objects wedged between the seat back and seat cushion.
- Cargo interfering with the seat.
- After market items attached to, or sitting on, the seat (covers, mats, blankets, etc.).

These conditions can interfere with the occupancy sensor. If you have eliminated the above possibilities, and the airbag status is still incorrect, ask passengers to ride in the rear seats and contact Tesla to have the airbag system checked.

Note: The front passenger seat's sensing system affects the operation of the passenger front and side airbags only. The other passenger airbags are not affected.

Warning: Never seat a child on the front passenger seat, even if the passenger airbag is off. All occupants age 12 and under must ride in the second and rear row seats (see [Child Safety Seats](#) on page 30).

Warning: To ensure accuracy of the occupant detection system, do not make any modifications to the front passenger seat.

Warning: Do not use seat covers on Model X. Doing so could restrict deployment of the seat-mounted side air bags if a collision occurs. It can also reduce the accuracy of the occupant detection system, if equipped.

Inflation Effects

Warning: When airbags inflate, a fine powder is released. This powder can irritate the skin and should be thoroughly flushed from the eyes and from any cuts or abrasions.



After inflation, the airbags deflate to provide a gradual cushioning effect for the occupants and to ensure the driver's forward vision is not obscured.

If airbags have inflated, or if your vehicle has been in a collision, always have the airbags, seat belt pre-tensioners and any associated components checked and, if necessary, replaced by Tesla.

In a collision, in addition to the airbags inflating:

- Doors and liftgate unlock.
- Hazard warning lights turn on.
- Interior lights turn on.
- High voltage is disabled.

To restore Battery power, use the touchscreen to manually power off Model X (see [Powering Off](#) on page 48), then press the brake to power it back on again.

Airbag Warning Indicator



The airbag indicator on the instrument panel remains lit if the airbag system is malfunctioning. The only time this indicator should light up is briefly when Model X first powers up, in which case it turns off within a few seconds. If it remains lit, contact Tesla immediately and do not drive.

Airbag Warnings

- Warning:** Do not place objects over or near airbags because any such objects could cause harm if the vehicle is in a crash severe enough to cause the airbag to inflate.
- Warning:** All occupants, including the driver, should always wear their seat belts, whether or not an airbag is also provided at their seating position, to minimize the risk of severe injury or death in the event of a collision.
- Warning:** Front seat occupants should not place their arms over the airbag module, as an inflating airbag can cause fractures or other injuries.
- Warning:** Airbags inflate with considerable speed and force, which can cause injury. To limit injuries, ensure that occupants are wearing seat belts and are correctly seated, with the seat positioned

as far back as possible. The National Highway Traffic Safety Administration (NHTSA) recommends a minimum distance of 10" (25 cm) between an occupant's chest and an airbag.

- Warning:** Do not use a child safety seat or seat young children on a seat with an operational airbag in front of it. Doing so can cause injury or death if the airbag inflates.
- Warning:** To ensure correct inflation of the side airbags, maintain an unobstructed gap between an occupant's torso and the side of Model X.
- Warning:** Passengers shouldn't lean their heads against doors. Doing so can cause injury if a curtain airbag inflates.
- Warning:** Do not allow passengers to obstruct the operation of an airbag by placing feet, knees or any other part of the body on or near an airbag.
- Warning:** Do not attach or place objects on or near the front airbags, the side of the front seats, the headliner at the side of the vehicle, or any other airbag cover that could interfere with inflation of an airbag. Objects can cause serious injury if the vehicle is in a collision severe enough to cause the airbag to inflate.
- Warning:** Following inflation, some airbag components are hot. Do not touch until they have cooled.



Creating a Driver Profile

When you first adjust the driver's seat, steering wheel, or driver's side mirror, the touchscreen prompts you to create a driver profile to save these adjustments. Your profile also saves some of the preferences you make using the touchscreen's Settings window.



To add a new driver profile, touch **Controls > Settings > Driver Profiles** (you can also touch the driver icon on the touchscreen's status bar). Then touch **Add New Driver**, type the driver's name and touch **Create Profile**. Follow the onscreen instructions to save the seating position to the driver profile. You can also check the **Use Easy Entry** checkbox if you want to save (or use existing) Easy Entry settings in which the driver's seat and the steering wheel are automatically adjusted to make it easy to enter and exit Model X.

If you change the position of the steering wheel, driver's seat, or driver's side mirror after you have saved or chosen a driver profile, the touchscreen prompts you to save the new position or restore the previously saved position (other settings are automatically saved). To change a setting without saving or restoring, just ignore the prompt.

To adjust Model X based on a driver's profile, touch the driver profile icon and choose the driver name. The saved adjustments are automatically made.

Note: Valet mode is a built-in driver profile used to limit speed and restrict access to some Model X features (see [Valet Mode](#) on page 43).

Easy Entry

You can define an Easy Entry setting that moves the steering wheel and driver's seat to make it easy to enter and exit Model X. Any driver can use the Easy Entry setting by associating it with their driver's profile. When the Easy Entry setting is associated with a driver's profile, the steering wheel and driver's seat automatically adjust when the park gear is engaged and the driver's seat belt is unbuckled, allowing an easy exit from the vehicle. When returning to the vehicle and stepping on the brake pedal, settings automatically adjust back to the settings used by the most recent driver profile (or based on the key if it's linked to a driver profile).

To set up Easy Entry, touch **Controls > Settings > Driver Profiles** (or touch the driver icon on the touchscreen's status bar). Choose a driver profile, check the **Easy Entry** checkbox and follow the onscreen instructions to save how you want the steering wheel and seat positioned when entering and exiting Model X. Once created, the Easy Entry profile appears on the driver profile list and any driver can use these settings to enter and exit.

Restoring a Driver's Profile



To adjust Model X based on a driver's profile, touch the driver profile icon on the touchscreen's status bar. Then choose the driver and Model X is adjusted based on the settings that have been saved to the chosen driver profile.

See What's Saved

To see what settings are associated with a driver profile, touch **Controls > Settings > Driver Profiles**. Then touch **See what's saved**. A popup window lists all the settings that are saved to driver profiles.

Note: The settings that are associated with driver profiles may vary depending on the version of software currently installed on your Model X.



Linking a Driver Profile to a Key

You can link a driver profile to a specific key to allow Model X to automatically select the correct driver profile when the linked key is detected as you approach the vehicle and open the driver's door. To link a driver profile to a key, enter Model X with the key and touch **Controls** > **Settings** > **Driver Profiles** on the vehicle's touchscreen. Select the driver profile you would like to link to the key, then touch **Link to Key Fob**.

Note: Model X only detects one key at a time. The driver profile is linked to the key that is detected by the vehicle at that time. Therefore, if you want to link driver profiles to multiple keys, ensure that only the key that you would like to link the driver profile to is within detection range while performing the linking procedure. Move all other keys outside of the detection range (at least three feet (one meter) away from Model X).

Note: Model X can support up to eight linked keys. However, a driver profile can only be linked to one key.

To remove the link between a driver profile and key, touch **Controls** > **Settings** > **Driver Profiles**. Select the driver profile, then touch the **X** next to **Linked to Key Fob**.

Valet Mode

When Model X is in Valet mode, the following restrictions apply:

- Speed is limited to 70 mph (113 km/h).
- Maximum acceleration and power are limited.
- Front trunk and glovebox are locked.
- Home and Work locations are not available in the navigation system.
- Voice commands are disabled.
- Traffic-Aware Cruise Control is disabled.
- Most status bar functions are disabled.
- The Mobile Access setting is disabled.
- HomeLink (if applicable in your market region) is not accessible.
- Driver Profiles are not accessible.
- Summon is disabled.

- Wi-Fi and Bluetooth are disabled. When Model X is in Valet mode, you cannot pair new Bluetooth devices or view or delete existing paired devices.

Note: If a Bluetooth paired device or a known Wi-Fi network is within operating range (approximately 30 feet or 9 meters) of Model X in Valet mode, Model X will connect to it.

Starting Valet Mode

With Model X in Park, touch the driver profile icon (located next to the Tesla "T" on the touchscreen), then touch **Valet Mode**.

The first time you enter Valet mode, you will be prompted to create a 4-digit PIN that you will use to cancel Valet mode.

When Valet mode is active, the instrument panel displays the word **Valet** above the driving speed and the Valet mode driver profile displays on the touchscreen.

You can also use the mobile app to start and cancel Valet mode (provided Model X is in Park). When using the mobile app, you do not need to enter a PIN because you are already required to log into the app using your Tesla Account credentials.

Note: If you forget your PIN, reset it from inside Model X by entering your Tesla Account credentials (which also cancels Valet mode). You can also reset your PIN using the mobile app.

⚠ Warning: Do not use Valet mode when towing a trailer. Torque limitations can make it difficult for Model X to pull a trailer up a hill.

Canceling Valet Mode

With Model X in Park, touch the **Valet Mode** driver icon on the touchscreen's status bar, then enter your 4-digit PIN.

When you cancel Valet mode, all settings associated with the most recently used driver profile and climate control settings are restored, and all features are available.

Note: You do not need to enter a PIN to cancel Valet mode from the mobile app.



Adjusting Position

Adjust the steering wheel to the desired driving position by moving the control on the left side of the steering column. Using this control, you can move the steering wheel forward and backward and up and down.

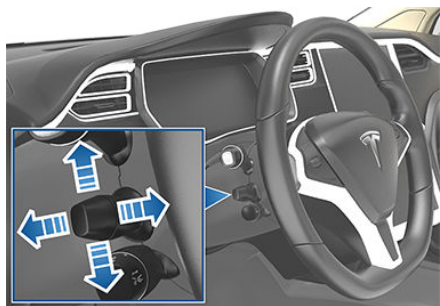

Warning: Do not make adjustments while driving.

Adjusting Sensitivity

You can adjust the feel and sensitivity of the steering system to suit your personal preference:

1. On the touchscreen, touch **Controls**.
2. Choose a steering option:
 - **Comfort** - Reduces the effort required to turn the wheel. In town, Model X feels easier to drive and park.
 - **Standard** - Tesla believes that this setting offers the best handling and response in most conditions.
 - **Sport** - Increases the effort required to turn the wheel. When driving at higher speeds, Model X feels more responsive.

The only way to really know which option you like best is to try them.

Using Left Steering Wheel Buttons

Use the buttons on the left side of the steering wheel to change radio stations, control the media player's volume, and to choose what displays on the left side of the instrument panel (whenever the Navigation app is not displaying instructions).

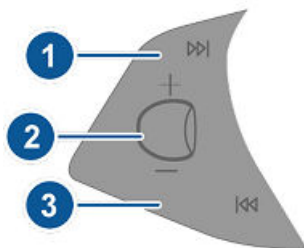

1. Next

If you are listening to local or satellite radio and you have defined more than one radio preset, press to play the next preset in the radio band that is currently playing. If you have not defined more than one preset, press to go to the next available frequency.

If you are listening to Internet radio, or to an audio file on a connected Bluetooth or USB device, press to skip to the next song or station.

If you have more than one favorite defined, press and hold to cycle through favorites.

2. Scroll Wheel

- To adjust the media volume, roll up or down.

Note: The scroll wheel adjusts the volume for media, navigation instructions and phone calls based on what is currently in use. As you adjust volume, the instrument panel displays the volume level and whether you are adjusting volume for media, navigation or phone.

- To mute the media volume, or to pause/play an audio file, tap the scroll wheel.



- To choose what displays on the left side of the instrument panel, press the scroll wheel briefly until the available options are displayed. Roll the scroll wheel to choose **Empty**, **Car Status**, **Clock**, **Media**, **Energy** or **Trips**, etc. When the option you want is highlighted, tap the scroll wheel.

Note: The option you choose to display using the left scroll wheel is retained until you manually change it. It is also saved in your driver profile.

Note: Car status displays information such as status of doors and trunks, and on newer model vehicles, the tire pressure measurements.

- To restart the touchscreen, hold both scroll wheel buttons for approximately 5 seconds. See [Restarting the Touchscreen](#) on page 48.

3. Previous

Same as described above for Next, except it skips to the previous song or station. If you have more than one favorite defined, press and hold to cycle through favorites.

Note: Regardless of how you customize the left side of the instrument panel, it automatically changes to display navigation instructions (if applicable), or to let you know if a door or trunk is open when Model X is in driving gear.

Using Right Steering Wheel Buttons

Use the buttons on the right side of the steering wheel to access call options while on a phone call, to choose what displays on the right side of the instrument panel, to adjust Model X features, and to use voice commands.

Note: Whenever you receive or make a phone call, the right side of the instrument panel automatically displays call options to help you easily handle phone calls on your Bluetooth-connected phone.

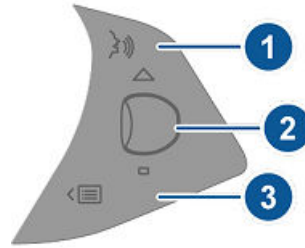

- Press to use a voice command to call a contact, navigate, or listen to Internet music. When you hear the tone, speak your command. Press again to end the voice command, or simply stop speaking. For details, see [Using Voice Commands](#) on page 46.

- Scroll Wheel

- During a phone call, touch the scroll wheel to display call options that allow you to perform an action on the call.
- Roll the wheel to adjust the most recently used feature from the feature list (see Menu button).
- To choose what displays on the right side of the instrument panel, press the scroll wheel briefly until the available options are displayed. Roll the scroll wheel to choose **Empty**, **Car Status**, **Clock**, **Media**, **Energy** or **Trips**, etc. When the option you want is highlighted, tap the scroll wheel.

Note: Car status displays information such as status of doors and trunks, and on newer model vehicles, the tire pressure measurements.

Note: The option you choose to display using the right scroll wheel is retained until you manually change it. It is also saved in your driver profile.

- To restart the touchscreen, hold both scroll wheel buttons for approximately 5 seconds. See [Restarting the Touchscreen](#) on page 48.

- Menu button

Press to display a menu that allows you to control the following Model X features:

- Temperature.** Roll the wheel to change the driver side temperature, or press the wheel to turn the climate control system on and off.



- **Fan Speed.** Roll the wheel to adjust the speed of the fan used to cool or heat the cabin.
- **Display Brightness.** Roll the wheel to change the brightness level of the displays, or press the wheel to restore default settings.
- **Recent Calls.** If your phone is paired to Model X, roll the wheel to view your recent calls. Press the wheel to call the contact that's displayed. To pair your phone, see [Pairing a Bluetooth Phone](#) on page 136.
- **Contacts.** If your phone is paired to Model X, use the scroll wheel to navigate to contacts in your phone. Your contacts are listed alphabetically by their last name. To pair your phone, see [Pairing a Bluetooth Phone](#) on page 136.

Press the menu button again to close the feature list.

Using Voice Commands

You can use voice commands to call a contact, navigate to a location, or listen to Internet music. Tap the voice button on the upper right side of the steering wheel to initiate a voice command. When you hear the tone, speak your command. As you speak, the instrument panel displays an interpretation of your command. (It also displays tips to remind you of the type of commands you can speak.) When you finish speaking the command, tap the voice button again or simply wait.

- To call a contact on your Bluetooth-connected phone, say "Call" or "Dial", followed by the contact's first and/or last name(s). For example, "Call Joe" or "Call Joe Smith".
- To search for, or navigate to, a location, say "Where is", "Drive to", or "Navigate to", followed by an address, business name, business category, or landmark. For example, "Where is Stanford University?", "Drive to Tesla in Palo Alto", or "Navigate to Starbucks on Homestead in Cupertino". If you have defined a navigation address for your home or work locations, you can use a voice command to navigate there by saying "Navigate home" or "Navigate to work".

- To listen to an Internet music service, say "Listen to" or "Play", followed by the name of the song, album, artist, or combination. To improve voice recognition accuracy, provide multiple cues in your command, such as artist plus song (for example, "Listen to Yellow Brick Road" or "Play Yellow Brick Road by Elton John").

Heated Steering Wheel

If Model X is equipped with the optional cold weather package, you can access a control that instantly warms up the steering wheel by touching **Controls > Cold Weather > Heated Wheel**. When turned on, a heater in the steering wheel provides radiant heat that keeps the steering wheel at a comfortable temperature.

Horn

To sound the horn, press the center pad on the steering wheel.





Adjusting Exterior Side Mirrors

Press the button associated with the mirror you want to adjust (left or right). The button's light turns on and you can then press the dial to move the mirror to the desired position. Repeat for the other side mirror. If prompted, touch **Save** on the touchscreen to save the mirror adjustment in your driver profile.



To fold and unfold exterior mirrors, press the center button. You can set the mirrors to fold automatically whenever Model X is locked by touching **Controls > Settings > Vehicle > Mirror Auto-Fold > ON**. The mirrors unfold automatically whenever you unlock Model X.

When you use the center button to fold the mirrors in for parking in a tight space, the mirrors remain folded in until your driving speed reaches 31 mph (50 km/h), or until you use the center button to unfold the mirrors.

Note: You cannot fold a mirror if driving above 31 mph (50 km/h).



The driver's side mirror automatically dims at night, in proportion to the level of glare from the headlights of a vehicle behind you (except when in Reverse gear). Also, both exterior side mirrors have heaters that turn on and off with the rear window defroster.

Mirror Auto-tilt When Reversing

Both exterior mirrors can automatically tilt downward when backing up. To adjust the auto-tilt position, shift into Reverse, then adjust the mirrors (press the button associated with the mirror you want to adjust, then press the dial to move the mirror to the desired position). Touch **Save** on the touchscreen to save the mirror adjustment in your driver profile.

When you shift back into Drive, the mirrors tilt back to their normal (upward) position. But now that you have adjusted them for backing up, they automatically tilt to the selected downward position whenever you shift into Reverse.

You can turn the auto-tilt feature on or off using the touchscreen, Touch **Controls > Settings > Vehicle > Mirror Auto-Tilt**.

Rear View Mirror

The rear view mirror is adjusted manually. Except when in Reverse, the rear view mirror automatically dims in proportion to the level of glare from the headlights of a vehicle behind you.



Starting

When you open a door, Model X powers on the instrument panel and touchscreen and you can operate all controls.

To drive Model X:

1. **PRESS THE BRAKE PEDAL** - Model X powers on and is ready to drive.
2. **SELECT A GEAR** - Move the gear lever all the way down for Drive and all the way up for Reverse. See [Shifting Gears](#) on page 50.

Note: If Passive Entry is off and you do not press the brake pedal to start Model X within approximately five minutes, a message displays on the instrument panel and you must use the key to lock then unlock Model X again before starting the vehicle.

Everything you need to know when driving Model X displays on the instrument panel.

Key Not Inside

If Model X does not detect a key when you press the brake, the instrument panel displays a message telling you that a key is not inside.

If you receive this message, place the key in the center console cup holder where Model X can best detect it.

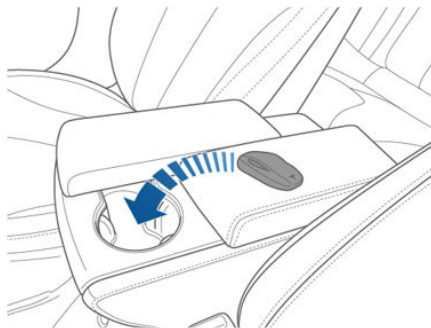

If Model X still does not detect the key, try holding it against the center console, immediately below the 12V power socket (see [12V Power Socket](#) on page 134). If the key is still not detected, remove the key's battery and try again. See [Replacing the Key Battery](#) on page 5. Or try using another key. If another key does not work, contact Tesla.

A number of factors can affect whether Model X can detect the key. These include a low battery in the key, interference from other devices using radio signals, and objects between the key and receiver.

Always keep the key with you. After driving, the key is needed to restart Model X after it powers off. And when you leave Model X, you must bring the key with you to lock Model X, either manually or automatically.

Powering Off

When you finish driving, shift into Park by pressing the button on the end of the gear selector. The parking brake automatically engages and all systems keep operating. When you leave Model X with the key, it powers off automatically, turning off the instrument panel and touchscreen.

Model X also powers off automatically after being in Park for 15 minutes, even if you are sitting in the driver's seat.

Although usually not needed, you can power off Model X while sitting in the driver's seat, provided the vehicle is not moving. Touch **Controls > E-Brake & Power Off > Power Off**. Model X automatically powers back on again if you press the brake pedal or touch the touchscreen.

Note: Model X automatically shifts into Park whenever it is determined that you are exiting the vehicle, even when you shift into Neutral before exiting. To keep Model X in Neutral, see [Keeping Your Vehicle in Neutral \(Tow Mode\)](#) on page 50.

Restarting the Touchscreen

If your touchscreen is unresponsive or demonstrates unusual behavior, restart it by shifting into Park then pressing and holding both scroll wheels on the steering wheel until the touchscreen turns black, releasing when the Tesla logo appears. Within approximately 30 seconds, the touchscreen restarts. If the touchscreen is still unresponsive or demonstrating unusual behavior, contact Tesla.

Note: Restarting the touchscreen does not power Model X off and on.

Warning: Paying attention to road and traffic conditions must always be the driver's highest priority. To ensure the safety of vehicle occupants as well as other road users, restarting the



touchscreen should be done only when the vehicle is in Park.



Shifting Gears

When Model X is in Park, you must press the brake to shift to another gear.

Move the lever up or down to change gears.

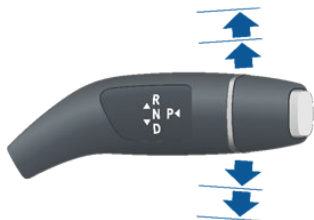

If you try to shift into a gear that the current driving speed prohibits, a chime sounds and the gear does not change.

Reverse

Push the lever all the way up and release. You can only shift into Reverse when Model X is stopped or moving less than 5 mph (8 km/h). If moving less than 1 mph (1.6 km/h), you must press the brake.

Neutral

Push the lever up or down to the first position and release to shift into Neutral. Neutral allows Model X to roll freely when you are not pressing the brake pedal.

If Model X is in Park and you use the touchscreen to release the parking brake (**Controls > E-Brake & Power Off**), Model X shifts into Neutral (see [Parking Brake](#) on page 63).

Model X automatically shifts into Park when you exit. To leave Model X in Neutral, use the touchscreen to engage Tow mode (see [Keeping Your Vehicle in Neutral \(Tow Mode\)](#) on page 50).

Drive

Push the lever all the way down and release. You can shift into Drive when Model X is stopped or moving less than 5 mph (8 km/h) in Reverse. If Model X is moving less than 1 mph (1.6 km/h), you must press the brake to shift into Drive.

Park

Press the end of the gear selector while Model X is stopped. Whenever Model X is in Park, the parking brake is applied.



Model X automatically shifts into Park whenever:

- Model X determines that you are exiting the vehicle.
- You connect a charge cable.

To make it convenient to pick up passengers, you can also unlock all doors at any time by shifting into Park then pressing the Park button a second time.

Keeping Your Vehicle in Neutral (Tow Mode)

Model X automatically shifts into Park whenever you finish driving and leave Model X. To keep Model X in Neutral when you exit, allowing it to roll freely (for example, pulling onto a transporter, etc.), activate Tow mode:

1. Shift into Park.
2. Press the brake pedal.
3. Touch **Controls > Settings > Service & Reset > Tow Mode**.

Model X beeps, and shifts into Neutral (which releases the parking brake).



When Tow mode is active, Model X displays this indicator light on the instrument panel, along with a message telling you that Model X will roll freely.

Note: In Tow mode, Model X does not shift into a driving gear. To cancel Tow mode, shift into Park or touch Tow mode again. Tow mode also cancels if you use the touchscreen to apply the parking brake (**Controls > E-Brake & Power Off > Parking Brake**).



Instrument Panel Overview

The instrument panel changes depending on whether Model X is:

- Off (shown below).
- Driving (see [Instrument Panel - Driving](#) on page 55).
- Charging (see [Charging Status](#) on page 157).

When Model X is off, the instrument panel shows remaining estimated range, status of doors, and outside temperature. When you press the brake, indicator lights flash on briefly along the top. Unless an indicator light applies to a current situation, it should turn off. If an indicator light fails to turn on or off, contact Tesla.

Note: The following illustration is provided for demonstration purposes only. Depending on vehicle options, software version, and market region, the information displayed may be slightly different.



The following indicators illuminate on the instrument panel to advise you or alert you of a specific condition.

Indicator	Description
	Low beam headlights are on.
	High beam headlights are on. Illuminates when high beams are on but the Auto High Beam setting is turned off or if the Auto High Beam setting is turned on but is temporarily unavailable. See High Beam Headlights on page 59.
	High beam headlights are currently turned on, and Auto High Beam is ready to turn off the high beams if light is detected in front of Model X. See High Beam Headlights on page 59.
	High beam headlights are temporarily turned off because Auto High Beam is on and is detecting light in front of Model X. When light is no longer detected, the high beams will automatically turn back on. See High Beam Headlights on page 59.



Low beam headlights are on.



High beam headlights are on. Illuminates when high beams are on but the Auto High Beam setting is turned off or if the Auto High Beam setting is turned on but is temporarily unavailable. See [High Beam Headlights](#) on page 59.











High beam headlights are currently turned on, and Auto High Beam is ready to turn off the high beams if light is detected in front of Model X. See [High Beam Headlights](#) on page 59.



High beam headlights are temporarily turned off because Auto High Beam is on and is detecting light in front of Model X. When light is no longer detected, the high beams will automatically turn back on. See [High Beam Headlights](#) on page 59.



Indicator	Description
	Parking lights (side marker lights, tail lights, and license plate lights) are on. See Lights on page 57.
	Front fog lights (optional). See Lights on page 57.
	Adaptive Front Lighting (if equipped). See Adaptive Front Lighting System (AFS) on page 59.
	Electronic stability control systems are actively minimizing wheel spin by controlling brake pressure and motor power (indicator flashes). See Traction Control on page 64. If this indicator stays illuminated, a fault is detected (contact Tesla immediately).
	A Smart Air Suspension fault is detected. Contact Tesla. See Smart Air Suspension on page 129.
	A brake system fault is detected or the brake fluid level is low. See Brakes on page 62. Contact Tesla immediately.
	Airbag safety. If this indicator does not flash on briefly when Model X prepares to drive, or if it remains on, contact Tesla immediately. See Airbag Warning Indicator on page 41.
	An ABS (Anti-lock Braking System) fault is detected. See Brakes on page 62. Contact Tesla immediately.
	The parking brake is manually applied. See Parking Brake on page 63.



Indicator	Description
-----------	-------------



A parking brake fault is detected. Contact Tesla. See [Parking Brake](#) on page 63.



Vehicle Hold is actively applying the brakes. See [Vehicle Hold](#) on page 67.



Tire pressure warning. The pressure of a tire is out of range. If a fault with the Tire Pressure Monitoring System (TPMS) is detected, the indicator flashes. For a TPMS fault, contact Tesla. See [Tire Care and Maintenance](#) on page 160.



A door or trunk is open. See [Doors](#) on page 4, [Rear Trunk](#) on page 13, or [Front Trunk](#) on page 15.



A seat belt for an occupied seat is not fastened. See [Seat Belts](#) on page 27.



Electronic stability control systems are no longer minimizing wheel spin (i.e. on a single motor vehicle, the traction control system has been turned off, or on a dual-motor vehicle, Slip Start has been enabled). See [Traction Control](#) on page 64.



Model X is in Tow mode and can roll freely. It does not automatically shift into Park when you exit. See [Instructions for Transporters](#) on page 191.



Trailer mode (if equipped) is active. See [Towing and Accessories](#) on page 75.



Flashes green when the left turn signal is operating. Both turn signal indicators flash green when the hazard warning flashers are operating.



Indicator	Description
-----------	-------------



Flashes green when the right turn signal is operating. Both turn signal indicators flash green when the hazard warning flashers are operating.



Instrument Panel - Driving

When Model X is driving (or ready to drive), the instrument panel shows your current driving status and a real-time visualization of the road as detected by Model X's Driver Assistance components (see [About Driver Assistance](#) on page 84).

Note: The following illustration is provided for demonstration purposes only. Depending on vehicle options, software version, and market region, the information displayed may be slightly different.

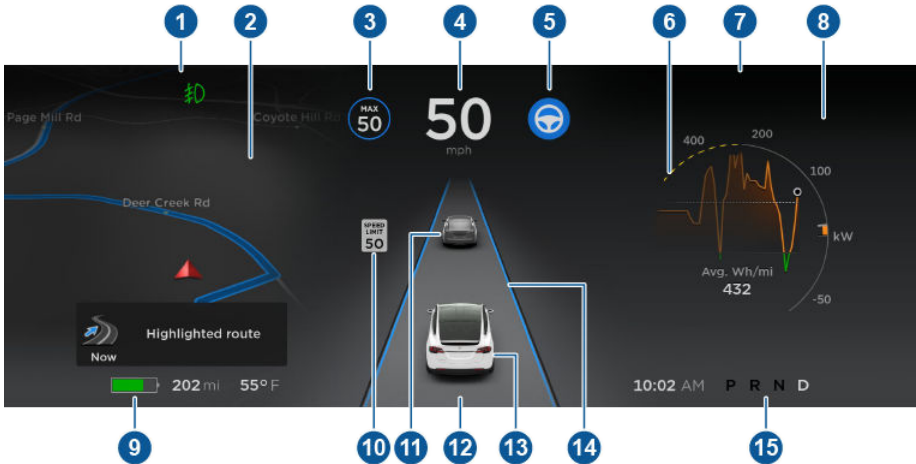

- Indicator lights display along the top to provide status (see [Instrument Panel Overview](#) on page 51).
- When you are actively navigating to a destination, navigation instructions display here. Use the left steering wheel buttons to change what displays on the left side of the instrument panel whenever navigation instructions are not displayed (see [Using Left Steering Wheel Buttons](#) on page 44).
- Traffic-Aware Cruise Control is cruising at a set speed. When Traffic-Aware Cruise Control is available but you haven't set a cruising speed, the icon is gray and the speed is not shown (see [Traffic-Aware Cruise Control](#) on page 87).
- Driving speed.
- Autosteer is actively steering Model X. When Autosteer is available but you haven't activated it, the icon is gray (see [Autosteer](#) on page 93).
- On the Energy graph, dashed lines appear on the power meter if Model X is limiting power. The dashed lines appear on the top portion (energy being used) when power available for acceleration is being limited, and on the bottom portion (energy being gained) when power that can be gained by regenerative braking is limited. Model X limits power for many reasons. Here are just a few examples:
 - Acceleration may be limited when the Battery is reaching a low state of charge or if the powertrain is hot.
 - Both acceleration and regenerative braking may be limited when the ambient temperature is either very high or very low.
 - Regenerative braking may be limited when the Battery is fully charged.

Note: Use the right steering wheel buttons to control what displays on the right side of the instrument panel (see [Using Right Steering Wheel Buttons](#) on page 45).



7. Pay attention to important alert messages that display here. If any alerts are in effect, you can view information about them by touching the alert icon (exclamation mark) on the touchscreen's status bar (the topmost area of the touchscreen).
8. Use the right steering wheel buttons to change what displays on the right side of the instrument panel whenever a phone call is not active (see [Using Right Steering Wheel Buttons](#) on page 45).
9. Total estimated driving distance (or energy) available. Instead of driving distance, you can display the percentage of battery energy remaining. To do so, touch **Controls > Settings > Units & Format > Energy & Charging** (see [Settings](#) on page 119).
Note: When anticipating when you need to charge, use range estimates as a general guideline only.
Note: In cold weather, some of the stored energy in the Battery may not be available on your drive because the Battery is too cold. When this happens, a portion of the Battery meter is blue and the driving distance value has a snowflake image next to it. If Model X is plugged in, you can heat your Battery using wall power by turning on climate control using the mobile app. When the Battery warms up, the blue portion on the meter and the snowflake image are no longer displayed.
10. The speed limit (if available) that is currently being detected by Speed Assist (see [Speed Assist](#) on page 109).
11. The car in front of you (if applicable).
12. Pay attention to important driving-related messages that appear at the bottom center of the instrument panel.
13. Your Model X.
14. When Autosteer is active and detects the driving lane, it is highlighted in blue (see [Autosteer](#) on page 93).
15. Currently selected gear: Park, Reverse, Neutral, or Drive.



Controlling Lights

Touch **Controls** on the bottom corner of the touchscreen to control most of the lights.

In addition to the lights that you can control from the touchscreen, Model X has convenience lights that turn on and off automatically based on what you are doing. For example, you will notice interior lights, marker lights, tail lights, door handle lights, and puddle lights that turn on when you unlock Model X, when you open a door, and when you shift into Park. They turn off automatically after a minute or two or when you shift into a driving gear or lock Model X.

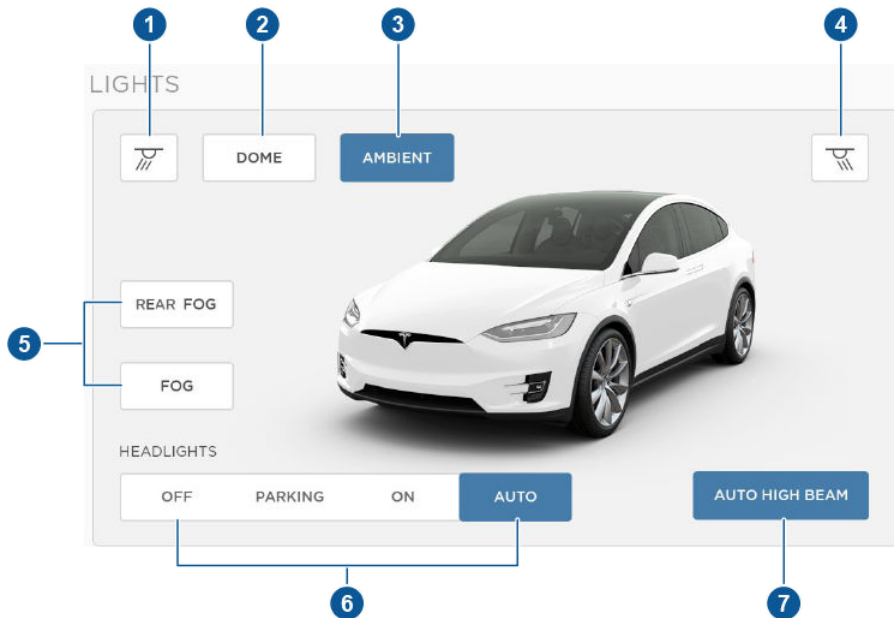



1. Touch to control front driver side map light.
2. If you touch **DOME**, a popup appears that allow you to control cabin lights. If cabin lights are set to **ON**, all interior cabin lights, including the light in the rear trunk, turn on when you unlock Model X, open a door upon exiting, or shift into P (Park). They turn off after 60 seconds, when you lock Model X, or when you shift into a driving gear. If set to **AUTO**, cabin lights turn on only when little or no light is detected.

You can also turn on an individual dome light by touching its lens. If you manually turn a dome light on, it turns off when Model X powers off. If Model X was already powered off when you manually turned the light on, it turns off after 60 minutes.

3. If you turn on **AMBIENT** lights, the lights on the door arm rests turn on whenever the headlights are on.
4. Touch to control front passenger side map light.
5. Touch to turn the fog lights on or off. Fog lights operate only when low beam headlights are on. When headlights are turned off, fog lights also turn off.



The Rear Fog indicator displays on the instrument panel whenever rear fog lights are on.



The Front Fog indicator displays on the instrument panel whenever the optional front fog lights are on.

6. Exterior lights (headlights, tail lights, side marker lights, parking lights, and license plate lights) are set to **AUTO** each time you start Model X.

AUTO

Exterior lights automatically turn on when driving in low lighting conditions. If you change to a different setting, lights always revert to this **AUTO** setting on your next drive.

Touch one of these options to temporarily change the exterior light setting:

OFF

Exterior lights turn off until you manually turn them back on or until the next time you drive Model X. If daytime running lights are required in your region, the exterior lights used for this purpose do not turn off.

PARKING

Only the side marker lights, parking lights, tail lights and license plate lights turn on.

ON

Exterior lights turn on.

Note: Model X has a series of lights along the lower rim of the headlights, also referred to as "signature" lights. These lights automatically turn on whenever Model X is powered on and a driving gear is engaged. In the U.S. only, these lights turn off to conserve energy when you turn the Range mode setting on (see [Controls](#) on page 116 or [Driving Tips to Maximize Range](#) on page 71).



Warning: Always ensure that your headlamps are switched to **AUTO** or **ON**, as appropriate, during all low visibility conditions. Failure to do so may result in a collision.

7. If you turn on **AUTO HIGH BEAM**, high beam headlights turn on and off automatically based on whether or not light is detected in front of Model X (see [High Beam Headlights](#) on page 59).



High Beam Headlights

Push the left-hand steering column lever away from you. To cancel, pull the lever toward you.



The high beam headlights can automatically switch to low beam when there is light detected in front of Model X (for example, from an oncoming vehicle). To turn this feature on, touch **Controls > Auto High Beam**.

Note: Your chosen setting is retained until you manually change it. It can also be saved in your driver profile.

In situations where high beams are turned off because AUTO HIGH BEAM is turned on and light is detected in front of Model X, you can temporarily turn on high beams by pulling the lever all the way toward you.

The following indicator lights are visible on the instrument panel when high beams are turned on:



High beam headlights are on. Illuminates when high beams are on but the Auto High Beam setting is turned off or if the Auto High Beam setting is turned on but is temporarily unavailable.



High beams are currently turned on, and Auto High Beam is ready to turn off the high beams if light is detected in front of Model X.



High beams are temporarily turned off because Auto High Beam is on and is detecting light in front of Model X. When light is no longer detected, the high beams will automatically turn back on.

To flash the headlight high beams, pull the lever fully toward you and release.

Warning: Auto High Beam is an aid only and is subject to limitations. It is the driver's responsibility to make sure that the headlights are always adjusted as

appropriate for the weather conditions and driving circumstances.

Headlights After Exit

When you stop driving and park Model X in low lighting conditions, the exterior lights automatically turn on. They automatically turn off after one minute or when you lock Model X.

You can turn this feature on and off using the touchscreen. Touch **Controls > Settings > Vehicle > Headlights After Exit**. When **Headlights After Exit** is set to **Off**, the headlights turn off when you engage the Park gear.

Adaptive Front Lighting System (AFS)

If equipped, the Adaptive Front Lighting System (AFS) automatically adjusts the beam of the headlights to improve your driving view. Electric sensors measure driving speed, steering angle and yaw (the rotation of the car around the vertical axis) to determine the optimum position of the headlights based on current driving conditions. For example, to improve visibility while driving on winding roads at night, the AFS casts the beam in the direction of the curve. When low beam headlights are turned on and when driving at lower speeds, AFS improves lateral illumination to increase the visibility of pedestrians and curbs, and to improve visibility when turning at a dark intersection, into a driveway, or when making a u-turn.

The Adaptive Front Lighting System (AFS) operates whenever headlights are on. If Model X isn't moving, or is moving in reverse, the adaptive headlights do not activate. This prevents the lights from inadvertently blinding other drivers. To turn the AFS off, touch **Controls > Settings > Vehicle > Adaptive Headlights > OFF**.





If the AFS fails, the instrument panel displays an alert. Contact Tesla Service.

Turn Signals

Move the left-hand steering column lever up (before turning right) or down (before turning left).



The turn signals stop operating when canceled by the steering wheel, or when you return the lever to the central position.

-  The corresponding turn signal indicator lights up on the instrument panel when a turn signal is operating. You also hear a clicking sound.
- 

 **Warning:** If you have purchased the optional Enhanced Autopilot or Full Self-Driving Capability packages and Traffic-Aware Cruise Control is active, engaging a turn signal can cause Model X to accelerate when using Traffic-Aware Cruise Control in specific situations (see [Overtake Acceleration](#) on page 90).

 **Warning:** If you have purchased the optional Enhanced Autopilot or Full Self-Driving Capability packages and Autosteer is active, engaging a turn signal may cause Model X to change lanes (see [Auto Lane Change](#) on page 96).

Lane Change Flash

To indicate a lane change, quickly press the lever up or down against the spring pressure, then release. The corresponding turn signal flashes three times.

Hazard Warning Flashers

To turn on the hazard warning flashers, press the button located on the side of the touchscreen closest to the steering wheel. All turn signals flash. Press again to turn off.

Note: Hazard warning flashers operate even without a Model X key nearby.



Wipers

To wipe the windshield, rotate the end of the left-hand steering column lever away from you. The steering column lever has five positions:

- 1st: Off.
- 2nd: Auto with low rain sensitivity.*
- 3rd: Auto with high rain sensitivity.*
- 4th: Continuous, slow.
- 5th: Continuous, fast.



For a single wipe, press and release the end of the lever.

If the wipers are set to Auto and Model X detects no liquid on the windshield, the wipers do not wipe.

When you operate the wipers, headlights automatically turn on (if they are not on already).

*To enable the Auto settings, touch **Controls > Settings > Vehicle > Autowipers (Beta) > ON**.

When wipers are set to an Auto setting, Model X detects whether or not it is raining. The frequency at which they wipe depends on how much rain is detected on the windshield. When wipers are set to high rain sensitivity, the wipers turn on when Model X detects a light mist.

Note: The Auto setting is currently in BETA. If uncertain about using the Auto setting while in the BETA phase, Tesla recommends operating the wipers manually, as necessary.

⚠ Caution: Ensure the wipers are in the Off position before washing Model X to avoid the risk of damaging the wipers.

To extend the life of wiper blades, remove ice from the windshield before turning wipers on. Ice has sharp edges that can damage the rubber on the blades.

Periodically check and clean the edge of the wiper blade. If damaged, contact Tesla Service.

⚠ Caution: In harsh climates, ensure that the wiper blades are not frozen or adhered to the windshield.

De-icing Wipers

To make wiper blades easy to access so you can remove any ice and snow, shift Model X into Park, turn the wipers off, then use the touchscreen to move them to the service position. Touch **Controls > Settings > Service & Reset > Service Mode > ON**. When parking in cold outdoor climates, it is helpful to leave Model X with the wipers in the service position. In this position, they are closer to the defrost vent, allowing you to thaw them by directing air from the climate control system towards the windshield.

Note: Wipers automatically return to their normal position when you shift Model X out of Park.

If Model X is equipped with the optional cold weather package, you can de-ice wipers by touching **Controls > Cold Weather > Heated Wipers**. Wiper heaters automatically turns off after 15 minutes.

Washers

Press the button on the end of the left steering column lever to spray washer fluid onto the windshield. You can press this button at two levels. Press partially for a single wipe, without any washer fluid. Press fully for both wipe and wash. When washing the windshield, the wipers will perform two wipes after you release the button, then a third wipe a few seconds later.



Periodically top up washer fluid (see [Topping Up Washer Fluid](#) on page 171).



Braking Systems

Warning: Properly functioning braking systems are critical to ensure safety. If you experience a problem with the brake pedal, brake caliper, or any component of a Model X braking system, contact Tesla immediately.

Model X has an anti-lock braking system (ABS) that prevents the wheels from locking when you apply maximum brake pressure. This improves steering control during heavy braking in most road conditions.

During emergency braking conditions, the ABS constantly monitors the speed of each wheel and varies the brake pressure according to the grip available.

The alteration of brake pressure can be felt as a pulsing sensation through the brake pedal. This demonstrates that the ABS is operating and is not a cause for concern. Keep firm and steady pressure on the brake pedal while experiencing the pulsing.



The ABS indicator flashes briefly on the instrument panel when you first start Model X. If this indicator lights up at any other time, an ABS fault has occurred and the ABS is not operating. Contact Tesla. The braking system remains fully operational and is not affected by an ABS failure. However, braking distances may increase.



If the instrument panel displays this indicator at any time other than displaying briefly when you first start Model X, a brake system fault is detected or the brake fluid level is low. Contact Tesla immediately.

Emergency Braking

In an emergency, fully press the brake pedal and maintain firm pressure, even on low traction surfaces. The ABS varies the braking pressure to each wheel according to the amount of traction available. This prevents wheels from locking and ensures that you stop as safely as possible.

Warning: Do not pump the brake pedal. Doing so interrupts operation of the ABS and can increase braking distance.

Warning: Always maintain a safe distance from the vehicle in front of you and be

aware of hazardous driving conditions. While the ABS can improve stopping distance, it cannot overcome the laws of physics. It also does not prevent the danger of hydroplaning (where a layer of water prevents direct contact between the tires and the road).

Automatic Emergency Braking automatically applies full braking in situations where a collision is considered imminent (see [Automatic Emergency Braking](#) on page 106).

Warning: Automatic Emergency Braking is not designed to prevent a collision. At best, it can minimize the impact of a frontal collision by attempting to reduce your driving speed. Depending on Automatic Emergency Braking to avoid a collision can result in serious injury or death.

Brake Wear

Model X brake pads are equipped with wear indicators. A wear indicator is a thin metal strip attached to the brake pad that squeals as it rubs against the rotor when the pad wears down. This squealing sound indicates that the brake pads have reached the end of their service life and require replacement. To replace the brake pads, contact Tesla Service.

Warning: Neglecting to replace worn brake pads damages the braking system and can result in a braking hazard.

Regenerative Braking

Whenever Model X is moving and your foot is off the accelerator, regenerative braking slows down Model X and feeds any surplus energy back to the Battery.

By anticipating your stops and reducing or removing pressure from the accelerator pedal to slow down, you can take advantage of regenerative braking to increase driving range. Of course, this is no substitute for regular braking when needed for safety.

Note: If regenerative braking is aggressively slowing Model X (such as when your foot is completely off the accelerator pedal at highway speeds), the brake lights turn on to alert others that you are slowing down.

Warning: In snowy or icy conditions Model X may experience traction loss during regenerative braking, particularly when in the **Standard** setting and/or not using winter tires. Tesla recommends



using the **Low** setting (see [To Set the Regenerative Braking Level](#) on page 63) in snowy or icy conditions to help maintain vehicle stability.

The Energy app displays real-time feedback on the amount of energy being gained by regenerative braking. You can also display the power meter on either side of the instrument panel by choosing **Energy** using the scroll button on the steering wheel (see [Steering Wheel](#) on page 44).

The amount of energy fed back to the Battery using regenerative braking can depend on the current state of the Battery and the charge level setting that you are using. For example, regenerative braking may be limited if the Battery is already fully charged or if the ambient temperature is too cold.

Note: If regenerative braking is limited, a dashed yellow line displays on the power meter.



To Set the Regenerative Braking Level

You can use the touchscreen to change the level of regenerative braking:

1. Touch **Controls > Driving > Regenerative Braking**.
2. Choose from two levels:
 - **Standard:** Provides the maximum amount of regenerative braking. When you release the accelerator, Model X slows down faster, reducing the need to use the brakes.

- **Low:** Limits regenerative braking. When you release the accelerator, Model X takes longer to slow down and coasts further than if set to Standard.

Parking Brake

The parking brake automatically engages when you shift Model X into Park, and releases when you shift into any other gear.



Note: The parking brake operates on the rear wheels only, and is independent of the pedal-operated brake system.

- Warning:** In snowy or icy conditions the rear wheels may not have sufficient traction to prevent Model X from sliding down a slope, particularly if not using winter tires. Avoid parking on hills in snowy or icy conditions. However, if parking in such conditions is absolutely necessary, have a second person place wheel chocks under the front wheels before releasing the brake pedal.

Use the touchscreen to manually release the parking brake (which also shifts Model X into Neutral):

1. Touch **Controls > E-Brake & Power Off**.
2. Press the brake pedal, then touch **Parking Brake**. If Model X was previously in Park, it shifts into Neutral.



The parking brake indicator lights up on the instrument panel whenever you use the touchscreen to manually apply the parking brake.



If an electrical issue occurs with the parking brake, an amber parking brake fault message displays at the top of the instrument panel.

- Caution:** In the unlikely event that Model X loses electrical power, you cannot access the touchscreen and are therefore unable to release the parking brake. Contact Tesla.



How It Works

The traction control system constantly monitors the speed of the front and rear wheels. If Model X experiences a loss of traction, the system minimizes wheel spin by controlling brake pressure and motor power. By default, the traction control system is on. Under normal conditions, it should remain on to ensure maximum safety.



This indicator flashes on the instrument panel whenever the traction control system is actively controlling brake pressure and motor power to minimize wheel spin. If the indicator stays on, a fault is detected with the traction control system. Contact Tesla Service.

Warning: If the above indicator remains illuminated in situations in which you have not enabled Slip Start (described next), the traction control system may not be operating correctly. Contact Tesla Service immediately.

Warning: Traction control cannot prevent collisions caused by driving dangerously or turning too sharply at high speeds.

Allowing Wheel Slip

To allow the wheels to spin at a limited speed, you can enable Slip Start. Slip Start can be enabled only when Model X is moving 30 mph (48 km/h) or slower. Slip Start automatically disables when the speed exceeds 50 mph (80 km/h).

Under normal conditions, Slip Start should not be enabled. Enable it only in circumstances where you deliberately want the wheels to spin, such as:

- Starting on a loose surface, such as gravel or snow.
- Driving in deep snow, sand or mud.
- Rocking out of a hole or deep rut.

To allow the wheels to spin, touch **Controls** > **Driving** > **Traction Control** > **Slip Start**.



The instrument panel displays an alert message when Slip Start is enabled.

Although Slip Start is automatically disabled the next time you start Model X, it is strongly recommended that you disable it immediately after the circumstances that required you to enable it have passed.

Note: Slip Start cannot be enabled when you are actively using Traffic-Aware Cruise Control.



How Park Assist Works

Model X has several sensors designed to detect the presence of objects. When driving slowly in Drive or Reverse (for example, when parking), the sensors alert you if an object is detected in close proximity of your Model X. Objects are only detected in the direction of the gear you selected; front objects in Drive, rear objects in Reverse.

⚠ Warning: You may not be alerted if Model X rolls freely in the opposite direction of the gear you selected (for example, you will not receive an alert if Model X rolls backwards down a hill while in Drive).

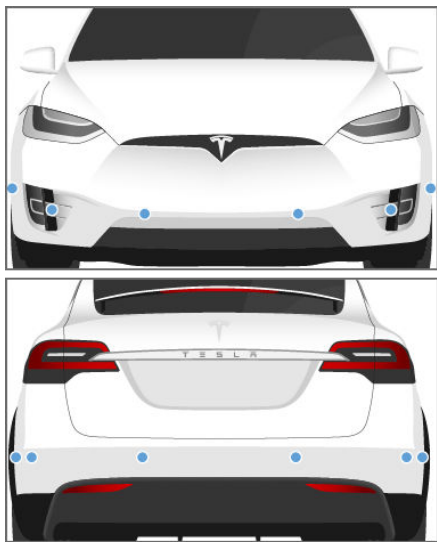

The sensors are activated when driving slower than 5 mph (8 km/h).

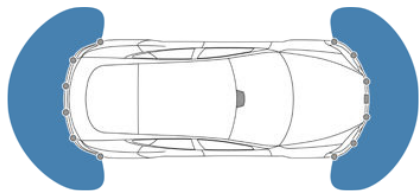

Note: Rear sensors are disabled when a bicycle is detected or Model X is in trailer mode.

⚠ Warning: Never depend on Park Assist to inform you if an area you are approaching

is free of objects and/or people. Several external factors can reduce the performance of Park Assist, causing either no readings or false readings (see [Limitations and False Warnings](#) on page 66). Therefore, depending on Park Assist to determine if Model X is approaching an obstruction can result in damage to the vehicle and/or objects, and can potentially cause serious injury. Always inspect the area with your own eyes. When reversing, perform shoulder checks and use all mirrors. Park assist does not detect children, pedestrians, bicyclists, animals, or objects that are moving, protruding, located too far above or below the sensors, or too close or too far from the sensors. Park Assist is for guidance purposes only and is not intended to replace your own direct visual checks. It is not a substitute for careful driving.

Visual and Audio Feedback

When you shift to Reverse, the Park Assist view displays on the left side of the instrument panel, showing objects that are in close proximity to the front and rear of Model X. This view closes when you shift into Drive unless an object is detected close to the front of Model X, in which case the Park Assist view closes automatically when your driving speed exceeds 5 mph (8 km/h). When reversing, visual feedback also displays on the touchscreen, immediately below the camera view (see [Rear View Camera](#) on page 73). You can manually close the park assist view on the touchscreen by touching the **X** in the upper left corner.

When driving with the Camera app displayed on the touchscreen, you can switch to the Park Assist view when driving at speeds below 5 mph (8 km/h). Touch the button located in the upper left corner of the Camera app window. This is useful if you need assistance with parallel parking.

If chimes are turned on (see [Controlling Audible Feedback](#) on page 66), an audible beep sounds as you approach an object. You can temporarily mute the chime by pressing the scroll wheel on the left side of the steering wheel or by touching the mute button located on the bottom left corner of the Park Assist view.

Note: If a sensor is unable to provide feedback, the instrument panel displays an alert message.



⚠️ Caution: Keep sensors clean from dirt, debris, snow, and ice. Avoid using a high pressure power washer on the sensors and do not clean a sensor with a sharp or abrasive object that can scratch or damage its surface.

⚠️ Caution: Do not install accessories or stickers on or near the parking sensors.

Controlling Audible Feedback

You can use Park Assist with or without audible feedback. To turn chimes on or off, touch **Controls > Settings > Safety & Security > Park Assist Chimes**.

To mute the chimes temporarily, press the scroll wheel on the left side of the steering wheel or touch the mute button in the bottom left corner of the Park Assist view. The chimes are muted until you shift into a different gear or drive over 5 mph (8 km/h).

Limitations and False Warnings

The parking sensors may not function correctly in these situations:

- One or more of the parking sensors is damaged, dirty, or covered (such as mud, ice, or snow).
- The object is located below approximately 8 inches (20 cm) (such as a curb or low barrier).

⚠️ Caution: Shorter objects that are detected (such as curbs or low barriers) can move into the blind spot of the sensors. Model X cannot alert you about an object while it is in the blind spot of the sensors.

- Weather conditions (heavy rain, snow, or fog) are interfering with sensor operation.
- The object is thin (such as a sign post).
- A sensor's operating range has been exceeded.
- The object is sound-absorbing or soft (such as powder snow).
- The object is sloped (such as a sloped embankment).
- Model X has been parked in, or being driven in, extremely hot or cold temperatures.
- The sensors are affected by other electrical equipment or devices that generate ultrasonic waves.
- The object is located too close to the bumper.

- A bumper is misaligned or damaged.
- An object that is mounted to Model X is interfering with and/or obstructing the sensor (such as a bike rack or bumper sticker).
- Model X rolls freely in the opposite direction of the gear you selected (for example, you will not receive an alert if Model X rolls backwards down a hill while in Drive).

Other Parking Aids

In addition to Park Assist, when shifted into Reverse, the backup camera displays a view of the area behind Model X (see [Rear View Camera](#) on page 73).



When Model X is stopped, Vehicle Hold can continue to apply the brakes even after you remove your foot from the brake pedal. When driving on a hill or on a flat surface, brake as you normally would. After coming to a complete stop, simply press the brake pedal again (until the instrument panel displays the Vehicle Hold indicator light) to enable Vehicle Hold. You can then release the brake pedal and remain stopped, even on a hill.



This indicator displays on the instrument panel whenever Vehicle Hold is actively braking Model X.

To disengage Vehicle Hold, press the accelerator pedal or press and release the brake pedal.

Note: Shifting into Neutral also disengages Vehicle Hold.

Note: After actively braking Model X for approximately ten minutes, Model X shifts into Park and Vehicle Hold cancels. Model X also shifts into Park if it detects that the driver has left the vehicle.



The acceleration settings available on your Model X vary depending on options chosen at time of purchase:

- **Chill:** limits acceleration for a smooth and gentle ride (available on all vehicles equipped with driver assistance hardware).
- **Standard:** provides the normal level of acceleration (available on non-performance dual motor vehicles).
- **Sport:** provides the normal level of acceleration (available on performance dual motor vehicles).
- **Insane:** increases peak torque by approximately 30 percent (available on performance dual motor vehicles not equipped with the Ludicrous upgrade).
- **Ludicrous:** increases peak torque by approximately 60 percent (available on performance dual motor vehicles equipped with the Ludicrous upgrade).

Note: Although Chill does not directly improve driving range, using the increased torque and power available in Insane or Ludicrous mode can reduce range and efficiency.

Note: When Chill is selected, Chill displays on the instrument panel above the driving speed.

In addition, a performance dual motor Model X also features Launch Mode to provide optimum acceleration on surfaces with good traction. For the specific driving instructions required to use Launch Mode, see [Launch Mode](#) on page 68.

To choose an acceleration mode, touch **Controls > Driving > Acceleration**.

Max Battery Power

If you choose Insane or Ludicrous, additional power is available immediately. However, to achieve the absolute maximum power (designed for short term use), you can enable Max Battery Power, which heats the Battery to its ideal operating temperature to ensure access to 100% of available power. Heating the Battery can take over an hour, depending on environmental conditions and whether or not Model X is being driven.

To enable, touch **Max Battery Power**, which displays as blue text immediately below the acceleration setting. While the battery is being heated, the touchscreen displays a message providing you with an approximate wait time, and when the additional power is available, the message indicates that Max Battery Power is READY!

Note: Max Battery Power is designed to achieve maximum performance for short term acceleration and is not intended for daily driving. The tradeoff for the additional power boost is extra energy consumption and earlier power fade on long drives. The Insane or Ludicrous acceleration settings provide a significant increase in performance even without Max Battery Power. In fact, in normal driving situations, the additional power that can be achieved using Max Battery Power may not be noticeable.

Note: To support Max Battery Power, the charge level must be 20% or higher. You cannot initiate Max Battery Power if the charge level is less than 20%. In addition, Max Battery Power immediately cancels if at any time during its use, the charge level drops below 20%.

When using Max Battery Power, Model X consumes more energy as it keeps the Battery within an optimal temperature range.

To cancel Max Battery Power at any time, change the acceleration level to Chill or Sport (or touch the button in the Max Battery Mode popup). To prevent excess and potentially unnecessary energy consumption (for example, you leave the vehicle and forget to cancel Max Battery Power), Max Battery Power cancels automatically in three hours, regardless of whether you are still driving or have left the vehicle.

Note: Max Battery Power strives to keep the pack within an optimal temperature range. In addition to heating the Battery, Max Battery Power also cools the battery when necessary (for example, while driving at high speeds, during rapid acceleration, driving for long periods, etc.).

Launch Mode

Launch Mode, available on performance dual motor vehicles only, provides optimum acceleration on surfaces with good traction.

Note: Hard acceleration including, but not limited to, using launch mode, increases stress on the vehicle's powertrain, and can cause premature wear and aging of various components. Model X constantly monitors powertrain fatigue and damage, and notifies you if vehicle components need to be serviced.

 **Warning:** Use Launch Mode only in appropriate locations where there is no cross traffic or pedestrians present.



Launch Mode is designed for use on closed circuit driving courses. It is the driver's responsibility to ensure that driving style and acceleration do not endanger or inconvenience other road users.

To Activate Launch Mode

Before activating Launch Mode, it is recommended that the brakes are slightly warm by driving for a few minutes and using the brakes a few times.

1. Set the acceleration level to **Insane** or **Ludicrous** and enable **Max Battery Power** (described above).

Note: You can use Launch Mode immediately after enabling **Max Battery Power**. There is no need to wait until Max Battery Power is in its READY state.

2. With Model X shifted into Drive and at a complete stop with the steering wheel straight, fully press the brake pedal with your left foot.
3. While still pressing the brake with your left foot, fully press the accelerator pedal with your right foot, then release the accelerator pedal. The instrument panel displays a message indicating that Launch Mode is enabled.
4. Within eight seconds, fully press the accelerator pedal a second time to pre-load motor torque, then within four seconds, release the brake.

When you release the brake, Model X launches forward.

Note: Launch Mode is not available if Slip Start has been enabled (i.e. wheels can spin). See [Traction Control](#) on page 64.

Note: Launch Mode is available only if the ambient temperature is 37° F (3° C) or warmer.



Displaying Trip Information

Trip information displays on the touchscreen when you touch **Controls > Trips**. For the current trip, you can display distance, duration and average energy usage. You can also show distance and total and average energy used since your last charge and for additional trips.

To name or rename a trip, touch the trip's name, enter a new name for the trip, then press **Save**. To reset a particular trip meter, touch its associated **Reset** button.

You can display information for up to three trips on the instrument panel. Use the checkboxes to specify the trip(s) you want to display. Then use the scroll bar on the steering wheel to display the chosen trip(s) (see [Using Left Steering Wheel Buttons](#) on page 44 or [Using Right Steering Wheel Buttons](#) on page 45).

Odometer

To display the odometer, touch the Tesla "T" at the top center of the touchscreen.



Driving Tips to Maximize Range

You can maximize your driving range using the same driving habits that you use to conserve fuel in a gasoline-powered vehicle. In addition to driving habits, energy consumption depends on environmental conditions (such as exceptionally cold or hot weather and driving on roads with steep hills). To get the maximum mileage from a charge:

- Slow down your driving and avoid frequent and rapid acceleration.
- If safe to do so, modulate the accelerator pedal instead of using the brake pedal when gradually slowing down. Whenever Model X is moving and you are not pressing the accelerator pedal, regenerative braking slows down Model X and feeds surplus energy back to the Battery (see [Regenerative Braking](#) on page 62).
- Keep tires at the recommended inflation pressures (see [Tire Care and Maintenance](#) on page 160).
- Lighten your load by removing any unnecessary cargo.
- Fully raise all windows.
- Limit the use of resources such as heating, signature lighting, and air conditioning. Using seat heaters to keep warm is more efficient than heating the cabin. To automatically limit the amount of power that the climate control system uses to maintain the temperature of the Battery and the cabin area, touch **Controls > Driving > Range Mode > ON**.

The power meter on the instrument panel and the Energy app (described next) provides feedback on energy usage. With this feedback, you will soon become familiar with how driving habits and environmental conditions impact how much energy Model X is using.

Energy App

Use the Energy app to view real-time and projected energy usage. Choose from two types of charts:

- **Consumption** - display how much energy Model X has consumed over the past 5, 15 or 30 miles (10, 25 or 50 km).
Touch **Average Range** to display a graph of the average energy consumed over the past 5, 15 or 30 miles (10, 25 or 50 km). The average range and the energy usage data are used to predict the projected range. Touch **Instant Range** to display a graph of the energy consumed over the last few data points only. The instant range and the energy usage data are used to calculate the projected range.
- **Trip** - If your Model X is equipped with navigation, you can monitor the amount of energy being used while navigating to a destination. You can track actual usage against the initial prediction. The green line represents the actual usage whereas the gray line represents predicted usage. To change the zoom level, touch the zoom icon located in the top right corner of the chart.

Note: The "Trip" chart displays energy usage only if you are currently navigating to a destination.

Saving Energy

Model X has an energy-saving feature that reduces the amount of energy being consumed when Model X is not in use. Touch **Controls > Displays > Energy Saving** and choose from the following options:

- **OFF** - Model X shifts to the energy-saving mode at night (10 pm to 5 am).
- **ON** - significantly less energy is consumed whenever Model X is not in use. The start-up time of the instrument panel and Bluetooth could be slower.
- **Always Connected** - preserves cell connectivity when energy saving is active. This allows the mobile app to connect to Model X quicker, and provides immediate internet access when entering the car. Slightly more energy is consumed.

Range Assurance

Model X helps protect you against running out of energy. Model X continuously monitors its energy level and proximity to known charging locations.



Getting Maximum Range



The map displays superchargers only.



The map displays superchargers, destination chargers, and visited chargers. In situations where a charging location may not be reachable based on your currently available driving range, its associated icon on the map displays as semi-transparent.

When you are at risk of driving beyond the range of known charging locations, the touchscreen displays a message giving you the opportunity to display a list of charging locations that are within range. When you select a charging location from the list, Model X provides navigation instructions and the turn-by-turn direction list displays the predicted amount of energy that will remain when you arrive at the charging destination.

In addition to the message that displays when you are at risk of driving beyond the range of known charging locations, a warning symbol displays on the range assurance icon:



Touch to display a search list of charging locations that are estimated to be within your driving range. Then touch a location in the search list to navigate to it.



Based on the amount of energy remaining in your Model X, there are no known charging locations within your driving range.



Camera Location

Model X is equipped with a rear view camera located above the rear license plate.

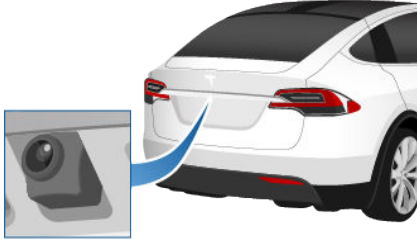

Whenever you shift into Reverse, the touchscreen displays the view from the camera. Lines show your driving path based on the position of the steering wheel. These lines adjust appropriately as you move the steering wheel.

Note: Visual feedback from the parking sensors displays on the instrument panel (see [Park Assist](#) on page 65).

Warning: Never depend on the rear view camera to inform you if the area behind you is free of objects and/or people when reversing. The camera may not detect objects or barriers that can potentially cause damage or injury. In addition, several external factors can reduce the performance of the camera, including a dirty or obstructed lens. Therefore, depending on the rear view camera to determine if Model X is approaching an obstruction can result in damage to the vehicle and/or objects, and can potentially cause serious injury. Always inspect the area with your own eyes. When reversing, perform shoulder checks and use all mirrors. Use the camera for guidance purposes only. It is not intended to replace your own direct visual checks and is not a substitute for careful driving.

Cleaning the Camera

To ensure a clear picture, keep the camera lens clean, and free of obstructions. Remove any buildup of dirt by occasionally wiping the camera lens with a soft damp cloth.

Caution: Do not use chemical-based or abrasive cleaners. Doing so can damage the surface of the camera lens.



Model X has a rear spoiler designed to improve aerodynamics. If Model X is equipped with the active spoiler, the position of the spoiler can vary depending on the status and speed of Model X:

- When Model X is in Reverse or when driving speed is below 10 mph (16 km/h), the spoiler provides maximum visibility behind Model X.
- When driving speed exceeds 45 mph (72 km/h), the spoiler lowers to the position that provides the most effective aerodynamics.
- When Model X is powered off and locked, the spoiler retracts.

To allow the spoiler to automatically move as described above, touch **Controls > Settings > Service & Reset > Spoiler > Automatic**. To disable automatic movement of the spoiler, which keeps it in its extended position, choose the **Extended** setting.

Note: If the spoiler can not automatically lower or raise, the instrument panel displays an alert. Contact Tesla Service.



The towing package allows you to tow a trailer with your Model X. It also allows you to carry skis, snowboards, bicycles, etc. by attaching an accessory carrier to the hitch.

Carrying Accessories

The Model X towing package has a 2" hitch receiver that can support an accessory carrier.

The hitch receiver is designed to support vertical loads of up to 120 lbs (54 kg). When carrying bicycles or other items on the Model X hitch, always check to ensure that the maximum weight is not exceeded. When calculating weight, remember to include the weight of the accessory carrier. For example, assuming the carrier weighs 40 lbs, the weight threshold is sufficient for carrying two bicycles weighing approximately 40 lbs each, or four bicycles weighing approximately 20 lbs each.

⚠ Caution: The Model X hitch is designed to support up to 120 lbs (54 kg). Exceeding this maximum weight can cause significant damage.

⚠ Caution: Do not attempt to install a carrier on a Model X that is not equipped with the towing package. Doing so can cause significant damage.

To install and use an accessory carrier, the tow hitch must be connected (see [Connecting the Tow Hitch](#) on page 80). Then follow the instructions provided with your accessory carrier. Observe all regulations and legal requirements in your state/region that apply to carrying accessories.

The Model X towing package includes the wiring necessary for using an accessory carrier equipped with lights (see [Electrical Connections](#) on page 82). The package also includes Trailer Mode software (see [Trailer Mode](#) on page 78).



When you connect an accessory carrier's wiring harness, Model X detects a connection for trailer lights and this indicator illuminates on the instrument panel. Trailer Mode is disabled.

When carrying accessories, periodically confirm that the accessory carrier and its cargo remain secure at all times, and if applicable, that the lights on the accessory carrier are working.

Note: Go to www.tesla.com to purchase accessories for your Model X. Although third-

party products are available, Tesla recommends and supports only Tesla-approved products (see [Parts and Accessories](#) on page 173). The accessory products available for your Model X vary based on market region. Before attempting to install a non-Tesla carrier, review the product information to ensure compatibility.

Note: When not in use, the hitch receiver should be removed and stored in a dry location to prevent rust and corrosion. Keep the dust cover over the hitch housing to prevent dirt and debris from entering. (see [Disconnecting the Tow Hitch](#) on page 81).

⚠ Caution: A carrier may obscure your view from the rear view mirror, the rear camera(s), the rear ultrasonic sensors. In addition, some driver assistance features may not function as expected.

⚠ Warning: Tesla assumes no responsibility for damage or injuries resulting from installing and using an accessory carrier, for any omissions in the instructions accompanying an accessory carrier, or for your failure to follow the instructions. Damage caused by using an accessory carrier is not covered by the warranty.



Towing Capacity

The total trailer weight (including all cargo and additional equipment), and the trailer tongue weight, must never exceed the following:

Tires	Maximum Towing Capacity*	Maximum Tongue Weight**
245/45R19 110 V / Y	SAE Class III - 4960 lbs (2250 kg)	SAE Class III - 500 lbs (227 kg)
275/45R20 110 V / Y	SAE Class III - 4960 lbs (2250 kg)	SAE Class III - 500 lbs (227 kg)
285/35R22 106 W	SAE Class II - 3480 lbs (1580 kg)	SAE Class II - 350 lbs (158 kg)

*Tesla recommends a separate braking system on trailers with a loaded weight of over 1000 lbs (450 kg). The braking system must be appropriate for the weight of the trailer. Follow the instructions provided by the trailer brake manufacturer to ensure that trailer brakes are properly installed, adjusted, and maintained.

**The tongue weight is the downward force that the weight of the trailer exerts on the hitch. It must not be less than 10% of the trailer load. Carrying a significant amount of equipment, passengers, or cargo in the tow vehicle can reduce the tongue weight it can handle, which also reduces the maximum towing capacity. Maximum towing capacity is calculated assuming the GVWR (Gross Vehicle Weight Rating) is not exceeded. The GVWR is printed on the Vehicle Certification Label (see [Vehicle Certification Label](#) on page 176).

Note: If the towing capacity on the hitch label conflicts with the information provided in this owner's manual, this owner's manual takes precedence.

 **Warning:** Do not overload the vehicle or trailer. Doing so can cause poor performance, vehicle damage and loss of vehicle control, resulting in serious injury or death.

 **Warning:** Do not use the trailer hitch to tow/transport Model X.

 **Caution:** Tesla assumes no responsibility for damage or injuries resulting from towing a trailer, for any errors or omissions in the instructions accompanying towing equipment, or for your failure to follow the proper instructions. Damage caused by towing a trailer is not covered by the warranty.



Tire Pressures when Towing

When towing a trailer, tire pressures must be adjusted to accommodate the additional load. Keep tires inflated to the pressures shown below (these pressures override the pressures that are provided on the Tire and Loading information label):

Front Tires	Rear Tires	Cold Tire Inflation Pressure
245/45R19	245/45R19	45 psi (310 kPa)
255/45R20 265/45R20	275/45R20	46 psi (320 kPa)
265/35ZR22	285/35ZR22	50 psi (345 kPa)

Warning: Check tire pressures using an accurate pressure gauge when tires are cold. Driving one mile (1.6 km) warms the tires sufficiently to affect tire pressures. Parking the vehicle in direct sunlight or in hot weather can also affect tire pressures. If you must check warm tires, expect increased pressures. Do not let air out of warm tires in an attempt to match recommended cold tire pressures. A hot tire at or below the recommended cold tire inflation pressure is dangerously under-inflated.

Warning: Never attempt to tow a trailer when a Model X tire is faulty or has been inflated using a tire repair kit. A temporarily repaired tire is not designed to sustain the towing load. Towing using a faulty or temporarily repaired tire can result in tire failure and loss of vehicle stability.

Before Towing a Trailer

Before towing a trailer, you must do the following:

- Inflate tires to the cold tire inflation pressure specified in Tire Pressures when Towing.
- Set Smart Air Suspension to **Standard** height (touch **Controls** > **Suspension** > **Standard**).

- Observe all regulations and legal requirements in your state/region that apply to trailer towing. Failure to comply with regulations can compromise your safety.
- Adjust side mirrors to provide a clear rearward view without a significant blind spot.
- Ensure that **Trailer Mode** is engaged.

Confirm the following:

- Model X rests horizontally with the trailer attached. If the vehicle is tipped sharply up at the front, and down at the rear, check that you are not exceeding the maximum towing capacity and tongue loads provided in Carrying Capacity.
- All trailer hitch parts and attachments, safety chains, and electrical connectors are in good condition and are properly connected. If any problems are apparent, do not tow the trailer.
- Trailer lights (brake lights, turn signal lights, and marker lights) are working properly.
- The trailer tongue is securely connected to the hitch ball.
- Safety chains are properly connected between the trailer and the tow vehicle. Cross the safety chains under the tongue of the trailer to help prevent the tongue from contacting the road if it separates from the hitch. Leave enough slack in the safety chains to allow for turns and ensure that the chains can never drag on the ground.
- All cargo is secured.
- The trailer load is evenly distributed such that the trailer tongue weight is approximately 10% of the total trailer weight, without exceeding the maximum tongue weights provided in Carrying Capacity.
- If the trailer is equipped with a separate braking system, check that the brakes work and are properly adjusted. To provide safe stopping ability, you must balance the trailer brakes with the vehicle brakes.

Note: For general information about trailer safety provided by the National Highway Traffic Safety Administration, go to: <http://www.nhtsa.gov/cars/problems/Equipment/towing/Towing.pdf>.

Warning: The trailer tongue weight must be approximately 10% of the total trailer weight without exceeding the maximum



tongue weights provided in Carrying Capacity. Loads that are balanced over the wheels or heavier in the rear can cause trailer sway, resulting in loss of vehicle control.

Warning: Always ensure that cargo is secured in the trailer and will not shift. Dynamic load shifts can cause loss of vehicle control, resulting in serious injury or death.

Trailer Mode

Trailer Mode must always be active when towing a trailer. When you connect a trailer's electrical connection, Model X automatically engages Trailer Mode. When you disconnect the trailer's electrical connection, Trailer Mode disengages. To engage or exit Trailer Mode manually, touch **Controls > Driving > Trailer Mode** on the touchscreen. One of the following indicators display on the instrument panel:



Trailer Mode is active.



Model X detects a connection for trailer lights but Trailer Mode is disabled. It is likely that a carrying accessory has been connected.



Model X detects a faulty electrical connection for the trailer lights. Some, or all, trailer lights may not be functioning. Pull over as soon as safety permits and inspect the trailer lights for faulty cabling or connections.

Note: In situations where Model X detects a heavy load, it assumes that a trailer is connected and automatically engages Trailer Mode. A message displays on the instrument panel informing you that Trailer Mode has been engaged. When Trailer Mode is entered automatically due to detection of a heavy load, you can change the Trailer Mode setting only by stopping Model X and engaging Park or engaging Neutral and manually applying the parking brake using the touchscreen (**Controls > Driving > E-Brake & Power Off > Parking Brake**).

Warning: Do not use Trailer Mode when attaching a carrying accessory to the trailer hitch.

In Trailer Mode, the following are disabled:

- Autosteer.
- Autopark.
- Rear parking sensors.

In addition, these features may operate differently:

- Traffic-Aware Cruise Control increases the following distance from the car in front of you.
- Smart Air Suspension will not make speed-based adjustments from **STANDARD** to **LOW**.
- Smart Air Suspension does not make automatic height adjustments based on saved location-based settings.
- Side collision warnings are active but automatic steering interventions are disabled.
- The braking force provided by Automatic Emergency Braking (see [Collision Avoidance Assist](#) on page 105) is significantly limited.

Warning: Do not rely on Model X to detect the trailer and automatically engage Trailer Mode. Always check that Trailer Mode is engaged before towing a trailer.

Warning: Under no circumstances should you exit Trailer Mode when towing a trailer. Doing so can cause serious injury and/or death.

Warning: Do not use the air suspension setting to appropriately match the height of the hitch with the height of the trailer. You must choose a trailer hitch and trailer that have the appropriate height for suitable axle loading and trailer balance.

Trailer Brakes

When towing a loaded trailer that weighs more than 1000 lbs (450 kg), Tesla recommends that the trailer be equipped with its own brake system adequate for the weight of the trailer. Ensure compliance with local regulations.

Follow these steps to connect a brake controller:



1. Connect the wiring on the brake controller to the appropriate locations on the 4-pin pigtail connector included with your Model X.

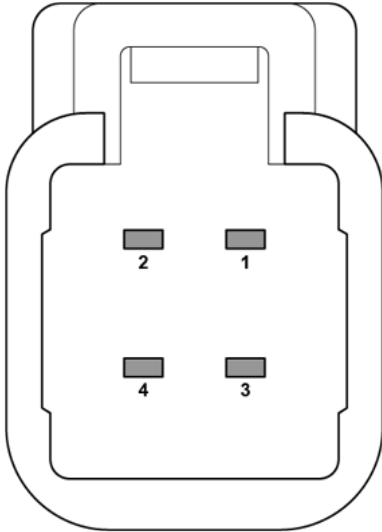

- 1 - Brake control output to trailer
- 2 - Ground
- 3 - Brake On Signal
- 4 - 12V Power (20A)

2. Remove the cover located under the dashboard in the driver's side foot well.
3. Peel back the carpet to expose Model X's 4-pin connector on the wiring harness.
4. Connect the pigtail connector to the vehicle wiring connector.

Warning: Towing increases your stopping distance, even when the trailer is equipped with its own braking system. When towing, increase your following distance and avoid situations that could potentially cause heavy braking. Failure to do so can result in a collision.

Warning: Observe all regulations and legal requirements in your regional and national jurisdictions that apply specifically to trailer towing and brake requirements. Many regions require a breakaway switch, located on the tongue of the trailer, to activate the trailer brakes in the event that the trailer separates

from the vehicle. Failure to comply with regulations can compromise your safety.

Warning: Follow the instructions provided by the trailer brake manufacturer to ensure that trailer brakes are properly installed, adjusted, and maintained. Tesla is not responsible for damages caused by incorrect installation of trailer braking systems.

Warning: Never attempt to connect trailer brakes directly to the vehicle braking system. Doing so can cause damage to the vehicle and the trailer, and can cause the braking system to malfunction, resulting in serious injury or death.

Towing Guidelines

Model X is designed primarily as a passenger-carrying vehicle. Towing a trailer puts additional load on the motor, drive train, brakes, tires, and suspension and significantly decreases range. If you decide to tow a trailer, proceed with caution and follow these general guidelines:

- Reduce your driving speed and avoid sudden maneuvers. Keep in mind that when towing a trailer, steering, stability, turning radius, stopping distance and braking performance are different when compared to driving without a trailer.
- Increase your following distance by maintaining twice the distance from a vehicle ahead. This helps to avoid situations that require heavy braking. Sudden braking may result in skidding or jack-knifing, and loss of control.
- Avoid very sharp turns. Sharp turns can cause the trailer to contact the vehicle and cause damage. Keep in mind that the trailer wheels are closer to the inside of the turn than the vehicle's wheels. Therefore, make wider turns to prevent the trailer from hitting curbs, road signs, trees or other objects.
- Periodically check the trailer lights and turn signals to confirm that bulbs are still working. When towing a trailer, the turn signal arrows on the vehicle instrument cluster flash as normal, even if the bulbs on the trailer are burned out.
- Periodically confirm the cargo is secure.
- Periodically confirm the trailer brakes are working.
- Avoid parking on a grade (see Parking with a Trailer).



- Regularly confirm that all towing components are securely tightened.

Parking with a Trailer

Whenever possible, avoid parking on a grade. However, if parking on a grade is absolutely necessary, place wheel chocks under the trailer wheels:

- One person presses and holds the brake pedal.
- A second person places the wheel chocks under the wheels on the downgrade side of the tires.
- When the chocks are in place, release the brake pedal and ensure the chocks hold the weight of the vehicle and trailer.

Note: When testing chocks, ensure that Vehicle Hold (see [Vehicle Hold](#) on page 67) is not engaged. If Vehicle Hold is braking Model X, the Vehicle Hold indicator light displays on the instrument panel. To disengage Vehicle Hold, press and release the brake pedal.

- Place the vehicle in Park. This engages the parking brake.

Warning: If parking on a grade is necessary, always ensure that all trailer wheels have been securely chocked. Failure to do so can result in serious damage, injury, or death.

Trailer Sway Mitigation

When trailer sway is detected, the Model X electronic stability control system attempts to apply the appropriate amount of braking to minimize trailer sway. The instrument panel briefly displays the traction control system indicator. Pressing the brake pedal when the system is actively braking to mitigate trailer sway does not cancel this automatic braking.

Connecting the Tow Hitch

The Model X towing package includes a weight-carrying hitch with a 2" x 2" removable hitch receiver. When not in use, the hitch receiver should be removed and stored in a dry location to prevent rust and corrosion. Keep the dust cover over the hitch housing to prevent dirt and debris from entering.

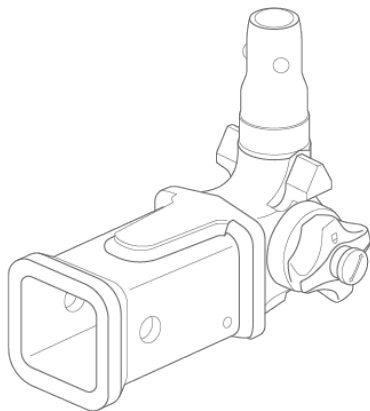

Note: Always remove the ball mount before installing or removing the hitch receiver from the vehicle (see [Attaching and Removing the Ball Mount](#) on page 82).

Warning: You must use the Model X trailer hitch when towing a trailer. Never attempt to attach a different type of trailer hitch.

To install the trailer hitch receiver:

1. Remove the dust cover from the hitch housing.

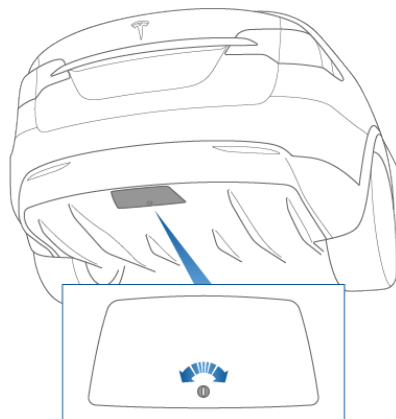

2. Insert the key into the locking cylinder on the hitch, and turn the cylinder so the top of the key is aligned with the "unlocked" position.



- Pull the locking cylinder out of the adapter approximately 1/8" (0.5 cm), and turn clockwise until the red marking on the cylinder aligns with the white dot.

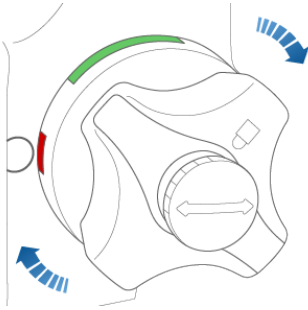

⚠ Warning: Be careful when turning the locking cylinder. If it does not lock into the "Open Position", it automatically retracts into its original "Closed Position" and can pinch your fingers.

- Firmly grasp the hitch from the bottom and align the triangular-shaped guides at the sides of the hitch with the corresponding cutouts in the hitch housing.

Note: Do not grasp the locking cylinder because it needs to rotate freely.

- Push the hitch into the hitch housing until the locking cylinder rotates approximately 120° counter-clockwise and automatically locks into the "Closed Position". The green area on the locking cylinder (above the white arrow) aligns with the white dot on the housing.
- Visually check to confirm that the hitch is fully inserted into the housing. Try pulling down on the hitch. The hitch should not drop when you pull down.

Note: If the hitch does not lock into the housing, it falls out when you pull down on it.

- Turn the key so the arrows align with the "locked" marking on the locking cylinder.

- Remove the key and store it in a safe place (preferably inside the vehicle).

Note: The key can be removed only if the hitch is locked. This indicates a proper connection. Do not use the hitch if the key is not removed.

Note: Tesla recommends making a note of the key code. You need this code if you lose the keys and need to order a replacement.

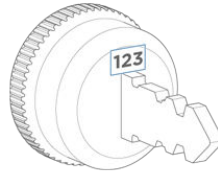

- Close the dust cover to prevent dirt and debris from entering the lock.

Note: To maintain the hitch, regularly grease its surfaces with non-resinous grease.

Disconnecting the Tow Hitch

After towing, remove the hitch:

- Insert the key and turn to align the top of the key with the "unlocked" position.
- While firmly holding the bottom of the hitch (to prevent it from dropping to the ground), pull the locking cylinder out approximately 1/8" (0.5 cm), and turn it clockwise until the red marking on the locking cylinder aligns with the white dot. At this point, the locking cylinder is locked in the "open" and the hitch drops out of the housing.

⚠ Warning: Be careful when turning the locking cylinder. If it does not lock into the "Open Position", it automatically retracts into its original "closed" position and can pinch your fingers.

- Reinstall the dust cover on the hitch housing to prevent dirt from accumulating inside the housing.
- Close the dust cover on the hitch's locking cylinder and store the hitch in a secure location.



Attaching and Removing the Ball Mount

The Model X towing package does not include a ball mount. You must purchase a ball mount suitable for the type of trailer you are towing. The Model X hitch receiver supports a ball mount up to 8" with a rise of up to 0.75". Do not use any type of drop ball mount.

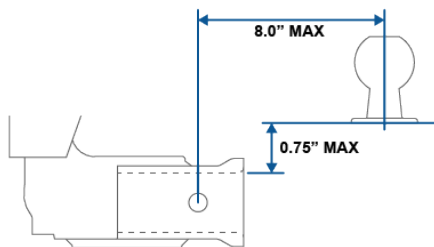

To attach a ball mount:

1. If necessary, remove the cotter pin from the locking bolt and slide the locking bolt out of the hitch assembly.
2. Slide the ball holder into the hitch assembly.
3. Align the hole in the ball holder with the one in the hitch assembly.
4. Slide the locking bolt through the hitch assembly/ball holder.
5. Insert the cotter pin in the hole at the end of the locking bolt.

To remove a ball mount:

1. Remove the cotter pin from the locking bolt and slide the locking bolt out of the ball holder/hitch assembly.
2. Pull the ball holder out of the hitch assembly.

Electrical Connections

Regulations require all trailers to be equipped with tail lights, brake lights, side marker lights, and turn signals. To provide power for trailer lighting, a built-in seven-way wiring connector (SAE J560) is attached to the tow bar near the tow hitch. Most trailer wiring plugs can be attached to this connector.

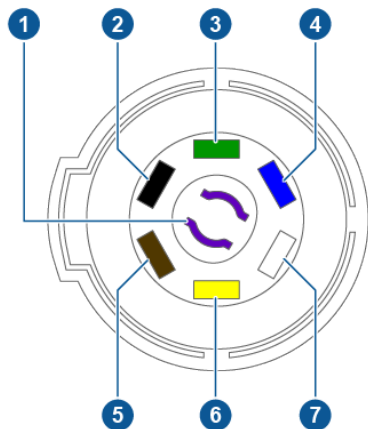

1. Reverse Lights (Purple)
2. 12V Power (Red or Black)
3. Right Turn Signal and Brake Light (Green)
4. Brake Controller Output (Blue)
5. Tail Lights and Running Lights (Brown)
6. Left Turn Signal and Brake Light (Yellow)
7. Ground (White)

Note: It is the driver's responsibility to ensure that all electrical connections are working and all trailer lights are operating before and during towing. Model X does not detect faulty trailer lights. You must perform manual checks.

Note: Loss of trailer lights when towing may be the result of a blown fuse. Model X does not provide a warning if the fuse is blown. Contact Tesla Service.

Plugging trailer wiring into the Model X electrical connector automatically engages Trailer Mode (see [Trailer Mode](#) on page 78).

Warning: The brake controller output operates only when a brake controller is installed (see [Trailer Brakes](#) on page 78).

Warning: Use only the electrical connection designed by Tesla. Do not attempt to directly splice or attempt to connect trailer electrical wiring using any other method. Doing so can damage the vehicle electrical system and cause malfunctions.

Caution: Always ensure that the trailer electrical cable does not contact or drag on the ground and there is enough slack in the cable to allow for turns.



Impact on Range

Towing a trailer and carrying accessories increases vehicle weight and drag. As a result, driving range can decrease significantly. Although Trip Planner attempts to adjust estimates based on Trailer Mode, actual energy consumption may vary. Plan trip length and charging destinations accordingly.



How It Works

Your Model X includes the following Driver Assistance components that actively monitor the surrounding roadway:

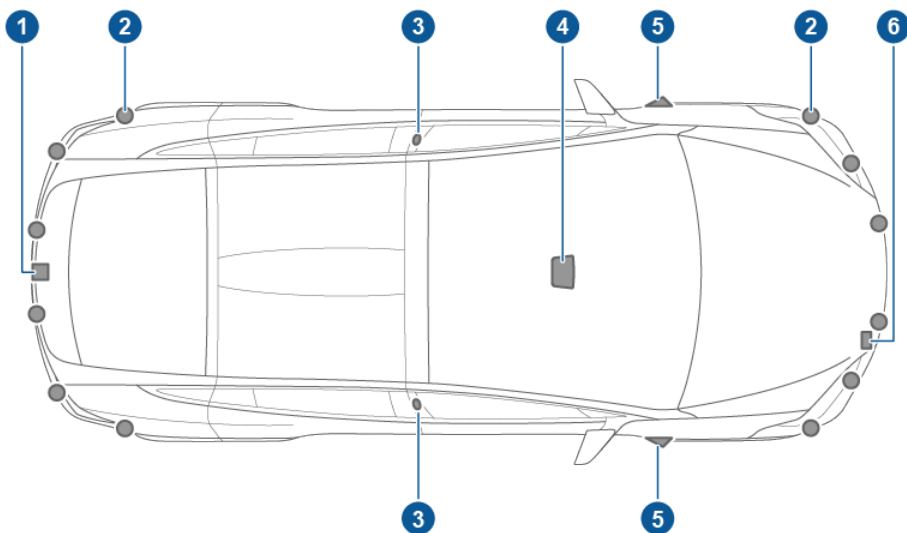

1. A camera is mounted above the rear license plate.
 2. Ultrasonic sensors are located in the front and rear bumpers.
 3. A camera is mounted in each door pillar.
 4. Three cameras are mounted to the windshield above the rear view mirror.
 5. A camera is mounted to each front fender.
 6. Radar is mounted behind the front bumper on the right side of the vehicle.
- Model X is also equipped with high precision electronically-assisted braking and steering systems.



Features

These safety features are available on all Tesla vehicles equipped with Driver Assistance components:

- Lane Assist (see [Lane Assist](#) on page 103).
- Collision Avoidance Assist (see [Collision Avoidance Assist](#) on page 105).
- Speed Assist (see [Speed Assist](#) on page 109).
- Auto High Beam (see [High Beam Headlights](#) on page 59).

These convenience features, designed to reduce driver workload, are available only if your Tesla vehicle is equipped with the optional Enhanced Autopilot or Full Self-Driving Capability packages:

- Traffic-Aware Cruise Control (see [Traffic-Aware Cruise Control](#) on page 87).
- Autosteer (see [Autosteer](#) on page 93).
- Auto Lane Change (see [Auto Lane Change](#) on page 96).
- Autopark (see [Autopark](#) on page 98).

You can enable/disable Driver Assistance features and in some cases, control how they work. To access settings for Driver Assistance features, touch **Controls** > **Settings** > **Driver Assistance**.

Calibration

Model X must maneuver with a great deal of precision when Driver Assistance features are being used. Therefore, before some features (for example, Traffic-Aware Cruise Control or Autosteer) can be used for the first time, some cameras must complete a self-calibration process.

Calibration typically completes after driving 20-25 miles (32-40 km), but the distance varies depending on road and environmental conditions. Driving on a straight road with highly-visible lane lines allows Model X to calibrate quicker. When calibration is complete, the features are available for use the next time you drive (i.e. you must stop and shift into Park before you can use the features). Contact Tesla if your Model X has not completed the calibration process after driving 100 miles (160 km).

Note: If you attempt to use a feature that is not available until the calibration process is complete, the feature will not be enabled and the instrument panel displays a message.

Note: Model X repeats the calibration process if the cameras are serviced by Tesla and in some cases, after a software update.

Limitations

Many factors can impact the performance of Driver Assistance components, causing them to be unable to function as intended. These include (but are not limited to):

- Poor visibility (due to heavy rain, snow, fog, etc.).
- Bright light (due to oncoming headlights, direct sunlight, etc.).
- Damage or obstructions caused by mud, ice, snow, etc.
- Interference or obstruction by object(s) mounted onto the vehicle (such as a bike rack).
- Obstruction caused by applying excessive paint or adhesive products (such as wraps, stickers, rubber coating, etc.) onto the vehicle.
- Narrow or winding roads.
- A damaged or misaligned bumper.
- Interference from other equipment that generates ultrasonic waves.
- Extremely hot or cold temperatures.

Warning: The list above does not represent an exhaustive list of situations that may interfere with proper operation of Driver Assistance components. Never depend on these components to keep you safe. It is the driver's responsibility to stay alert, drive safely, and be in control of the vehicle at all times.

Warning: If a windshield replacement is needed, take your vehicle to Tesla Service. This will ensure appropriate handling and mounting of the camera(s). Failure to do so can cause one or more Driver Assistance features to malfunction.

Cleaning Cameras and Sensors

To ensure the various Driver Assistance components can provide information that is as accurate as possible, keep them clean and free of obstructions or damage. Occasionally remove any buildup of dirt by wiping the components with a soft cloth dampened with warm water.

Caution: Do not use chemical-based or abrasive cleaners. Doing so can damage surfaces.



About Driver Assistance

 **Caution:** Avoid using a high-pressure power washer.

 **Caution:** Do not clean an ultrasonic sensor or camera lens with a sharp or abrasive object that can scratch or damage its surface.



Note: Traffic-Aware Cruise Control is a BETA feature.

If you have purchased the optional Enhanced Autopilot or Full Self-Driving Capability package, the forward looking cameras and the radar sensor are designed to determine when there is a vehicle in front of you in the same lane. If the area in front of Model X is clear, Traffic-Aware Cruise Control maintains a set driving speed. When a vehicle is detected, Traffic-Aware Cruise Control is designed to slow down Model X as needed to maintain a selected time-based distance from the vehicle in front, up to the set speed. Traffic-Aware Cruise Control does not eliminate the need to watch the road in front of you and to manually apply the brakes when needed.

Traffic-Aware Cruise Control is primarily intended for driving on dry, straight roads, such as highways and freeways. It should not be used on city streets.

Warning: Traffic-Aware Cruise Control is designed for your driving comfort and convenience and is not a collision warning or avoidance system. It is your responsibility to stay alert, drive safely, and be in control of the vehicle at all times. Never depend on Traffic-Aware Cruise Control to adequately slow down Model X. Always watch the road in front of you and be prepared to take corrective action at all times. Failure to do so can result in serious injury or death.

Warning: Although Traffic-Aware Cruise Control is capable of detecting pedestrians and cyclists, never depend on Traffic-Aware Cruise Control to adequately slow Model X down for them. Always watch the road in front of you and be prepared to take corrective action at all times. Failure to do so can result in serious injury or death.

Warning: Do not use Traffic-Aware Cruise Control on city streets or on roads where traffic conditions are constantly changing.

Warning: Do not use Traffic-Aware Cruise Control on winding roads with sharp curves, on icy or slippery road surfaces, or when weather conditions (such as heavy rain, snow, fog, etc.) make it inappropriate to drive at a consistent speed. Traffic-Aware Cruise Control does not adapt driving speed based on road and driving conditions.

Operating Traffic-Aware Cruise Control

To use Traffic-Aware Cruise Control, you must be driving at least 18 mph (30 km/h), unless a vehicle is detected ahead of you. If a vehicle is detected ahead of you, you can use Traffic-Aware Cruise Control at any speed, even when stationary, provided you are at least 5 feet (150 cm) away from the vehicle.

The minimum set speed is 18 mph (30 km/h). The maximum set speed is 90 mph (150 km/h). It is the driver's responsibility to cruise at a safe speed based on road conditions and speed limits.

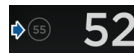

The instrument panel displays a gray speedometer icon on the left side of the driving speed to indicate that Traffic-Aware Cruise Control is available but is not currently active. The number shown in gray is determined by Speed Assist (see [Controlling Speed Assist](#) on page 109).

When driving at your desired speed, set the cruising speed by moving the cruise control lever up or down, then releasing.

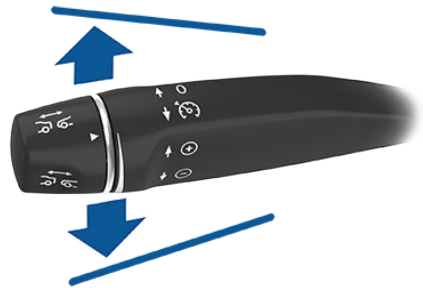

To set the cruising speed to the set speed as determined by Speed Assist (see [Controlling Speed Assist](#) on page 109), pull the cruise control lever towards you, then release.

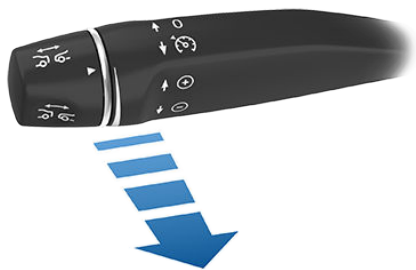

The gray speedometer icon on the instrument panel turns blue and displays the set speed to indicate that Traffic-Aware Cruise Control is active.

Note: The minimum set speed is 18 mph (30 km/h). The maximum set speed is 90 mph (150 km/h). It is the driver's responsibility to cruise at a safe speed based on road conditions and speed limits.

You can now release the accelerator pedal and allow Traffic-Aware Cruise Control to maintain your set speed. When no vehicle is detected ahead, Traffic-Aware Cruise Control maintains the set speed. If a vehicle is detected, Traffic-Aware Cruise Control maintains your chosen following distance, up to the set speed, accelerating and decelerating Model X as needed. When the vehicle you are following is no longer detected, Traffic-Aware Cruise Control accelerates up to the set speed. Traffic-Aware Cruise Control also adjusts the speed as appropriate when entering and exiting curves.

You can manually accelerate at any time when driving at a set speed using Traffic-Aware Cruise Control. But when you release the accelerator, Model X returns to the set speed.

When following a vehicle, Traffic-Aware Cruise Control remains active at low speeds, even if Model X comes to a standstill. When the vehicle is moving again, Traffic-Aware Cruise Control resumes operating at your current set speed. However, under the following circumstances, Traffic-Aware Cruise Control goes into a **HOLD** state instead of resuming, and the instrument panel displays a message indicating that you need to resume cruise control:

- You have been at a standstill for 5 minutes.
- The driver's seat belt is unbuckled.

- Model X detects a pedestrian nearby (the **HOLD** state may clear when the pedestrian is no longer close by).
- Model X suddenly loses visibility of the vehicle you are following.
- The ultrasonic sensors detect an obstacle in front of Model X.

To resume Traffic-Aware Cruise Control, press the accelerator pedal or pull the cruise control lever toward you (see [Canceling and Resuming](#) on page 91).

In right hand traffic, engaging the right turn signal when driving in the right-most lane within 164 feet (50 meters) of an exit (on a controlled access road only, such as a highway or freeway), causes Traffic-Aware Cruise Control to assume you are exiting. As a result, Traffic-Aware Cruise Control begins to slow down the vehicle. Likewise in left hand traffic, when engaging the left turn signal when driving in the left-most lane within 164 feet (50 meters) of an exit. The onboard Global Positioning System (GPS) determines if you are driving in a region with right or left hand traffic. In situations where GPS data is unavailable (for example, if there is inadequate signal), engaging the turn signal near an exit does not cause Traffic-Aware Cruise Control to slow down Model X.

Note: If you double-pull the cruise control lever (or single-pull when Traffic-Aware Cruise Control is active), Autosteer activates if enabled (see [Autosteer](#) on page 93) and the set speed changes to either your current driving speed, or the speed limit plus any offset you have defined in Speed Assist, whichever is greater (see [Cruising at the Speed Limit](#) on page 89).

Note: When Traffic-Aware Cruise Control is actively slowing down Model X to maintain the selected distance from the vehicle ahead, the brake lights turn on to alert other road users that you are slowing down. You may also notice slight movement of the brake pedal. However, when Traffic-Aware Cruise Control is accelerating Model X, the accelerator pedal does not move.

Warning: Due to limitations inherent in the onboard GPS, you may experience situations in which Traffic-Aware Cruise Control slows down the vehicle, especially near highway exits where a curve is detected and/or you are actively navigating to a destination and not following the route.



Warning: Traffic-Aware Cruise Control cannot detect all objects and may not brake/decelerate for stationary vehicles or objects, especially in situations when you are driving over 50 mph (80 km/h) and in situations where a vehicle you are following moves out of your driving path and a stationary vehicle or object is in front of you. Always pay attention to the road ahead and stay prepared to take immediate corrective action. Depending on Traffic-Aware Cruise Control to avoid a collision can result in serious injury or death. In addition, Traffic-Aware Cruise Control may react to vehicles or objects that either do not exist or are not in the lane of travel, causing Model X to slow down unnecessarily or inappropriately.

Warning: Traffic-Aware Cruise Control may be unable to provide adequate speed control because of limited braking capability and hills. It can also misjudge the distance from a vehicle ahead. Driving downhill can increase driving speed, causing Model X to exceed your set speed (and potentially the road's speed limit). Never depend on Traffic-Aware Cruise Control to slow down the vehicle enough to prevent a collision. Always keep your eyes on the road when driving and be prepared to take corrective action as needed. Depending on Traffic-Aware Cruise Control to slow the vehicle down enough to prevent a collision can result in serious injury or death.

Warning: Traffic-Aware Cruise Control may occasionally cause Model X to brake when not required or when you are not expecting it. This can be caused by closely following a vehicle ahead, detecting vehicles or objects in adjacent lanes (especially on curves), etc.

Adjust your following distance

To adjust the following distance you want to maintain between your Model X and a vehicle traveling ahead of you, rotate the cruise control lever to choose a setting from 1 (the closest following distance) to 7 (the longest following distance). Each setting corresponds to a time-based distance that represents how long it takes for Model X, from its current location, to reach the location of the rear bumper of the vehicle ahead of you.



As you rotate the cruise control lever, the instrument panel displays the current setting. Release the lever when the desired setting is displayed.



Note: Your setting is retained until you manually change it.

Warning: It is the driver's responsibility to determine and maintain a safe following distance at all times. Do not rely on Traffic-Aware Cruise Control to maintain an accurate or appropriate following distance.

Warning: Never depend on Traffic-Aware Cruise Control to adequately slow down Model X to avoid a collision. Always watch the road in front of you and stay prepared to take immediate corrective action.

Cruising at the Speed Limit

Traffic-Aware Cruise Control makes it easy to cruise at the speed limit. You can cruise at the speed limit that is currently being determined by Speed Assist (see [Speed Assist](#) on page 109). To do so, pull the cruise control lever toward you. When you release, your cruising speed is set to the speed that is determined by Speed Assist, taking into consideration any offset you have specified. If you are already driving faster than the speed limit when you pull the lever, the set speed does not adjust to the speed limit—it adjusts to your current driving speed.

Note: When you adjust the cruising speed based on the speed limit, the set speed does not change when the speed limit changes. You must pull the cruise control lever again to cruise at the new speed limit. You can also manually adjust your cruising speed at any time (see [Changing the Set Speed](#) on page 90).



Note: Your set speed will use your current driving speed if you move the cruise control lever up or down.

Note: If Speed Assist is unable to determine a speed limit, your set speed does not change when you pull the cruise control lever toward you.

Warning: Do not rely on Speed Assist or Traffic-Aware Cruise Control to determine an accurate or appropriate cruising speed. Always cruise at a safe speed based on road conditions and applicable speed limits.

Changing the Set Speed

To change the set speed while using Traffic-Aware Cruise Control, move the cruise control lever up (increase) or down (decrease) until your desired set speed is displayed.

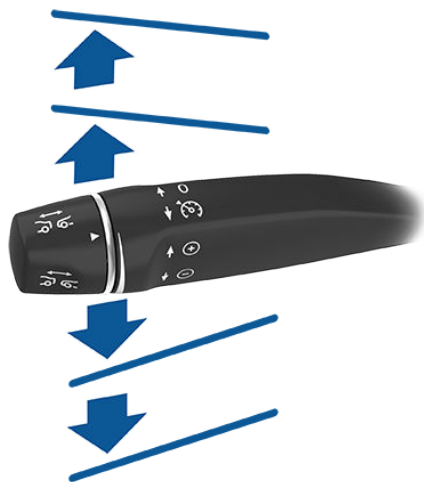

To increase/decrease speed by 1 mph (1 km/h), move the lever up or down to the first position and release. To increase/decrease speed to the closest 5 mph (5 km/h) increment, move the lever up/down to the second position and release. For example, if you are traveling at 57 mph and you move the lever up to the second position and release, the speed increases to 60 mph. You can also increase/decrease speed by holding the lever in the full up/down position and releasing when the desired speed displays below the cruise control icon.

To cruise at the speed limit that is currently being determined by Speed Assist (including any offsets that you have set), pull the cruise control lever toward you. See [Speed Assist](#) on page 109.

Note: It may take a few seconds for Model X to reach the new cruising speed, assuming Model X does not detect a vehicle ahead driving slower than your set speed.

Overtake Acceleration

When following a vehicle with Traffic-Aware Cruise Control active, briefly engaging the turn signal (to indicate a move into the passing lane) accelerates Model X towards the vehicle ahead. By momentarily holding the turn signal lever up or down, you can quickly accelerate up to your set speed without having to press the accelerator pedal. The turn signal accelerates only when the following conditions are met:

- Traffic-Aware Cruise Control is operating and detects a vehicle in front of you.
- No obstacles or vehicles are detected in the target lane.
- Model X is traveling below the set speed, but over 45 mph (72 km/h).

Overtake Acceleration is intended as an aid when passing a vehicle ahead of you. When the turn signal is engaged, Traffic-Aware Cruise Control continues to maintain distance from the vehicle ahead, but allows you to drive slightly closer than your selected distance.

Acceleration cancels when:

- You reach your set cruising speed.
- Changing lanes takes too long.
- Model X gets too close to the vehicle ahead.

OR

- You disengage the turn signal.

Note: Overtake Acceleration occurs when you either fully engage the turn signal, or you hold the turn signal in the momentary position (partially engaged). When you release or disengage the turn signal, Model X stops accelerating (in the same way as when you release the accelerator pedal) and resumes the set speed.

Warning: Overtake Acceleration can cancel for many unforeseen reasons in addition to those listed above (for example, lack of GPS data). Stay alert and



never depend on Overtake Acceleration to increase your driving speed.

Warning: Overtake Acceleration increases your driving speed whenever the appropriate turn signal is engaged, and accelerates Model X closer to the vehicle ahead. Although Traffic-Aware Cruise Control continues to maintain distance from the vehicle ahead, it is important to be aware that your selected following distance is reduced when Overtake Acceleration is active, particularly in cases where it may not be your intention to overtake the vehicle you are following.

Canceling and Resuming

To manually cancel Traffic-Aware Cruise Control, briefly push the cruise control lever away from you or press the brake pedal. The speedometer icon on the instrument panel turns gray to indicate that Traffic-Aware Cruise Control is not actively controlling your speed.



To resume cruising at the previously set speed, briefly pull the cruise control lever toward you.

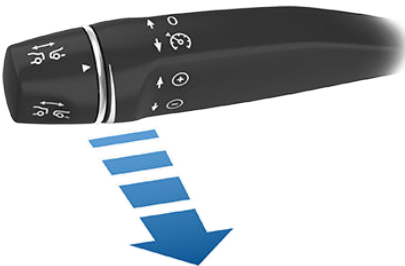

To resume cruising at the current driving speed, move the cruise control lever up or down, then release

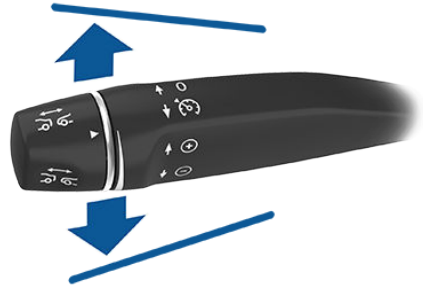

Note: When Traffic-Aware Cruise Control cancels, Model X does not coast. Instead, regenerative braking slows down Model X in the same way as when you move your foot off the accelerator when driving without Traffic-Aware Cruise Control (see [Regenerative Braking](#) on page 62).

Warning: Traffic-Aware Cruise Control cancels, or may not be available, in the following situations:

- You press the brake pedal.
- Your driving speed drops below 5 mph (8 km/h) in situations when Model X does not detect a vehicle ahead within the specified distance.
- Your driving speed exceeds the maximum cruising speed of 90 mph (150 km/h).
- You shift Model X into a different gear.
- The driver's seat belt is unbuckled.
- A door is opened.
- The view from the radar sensor or camera(s) is obstructed. This could be caused by dirt, mud, ice, snow, fog, etc.
- The traction control setting is manually disabled or is repeatedly engaging to prevent wheels from slipping.
- The wheels are spinning while at a standstill.
- The Traffic-Aware Cruise Control system is failing or requires service.

When Traffic-Aware Cruise Control is unavailable or cancels, Model X no longer drives consistently at a set speed and no longer maintains a specified distance from the vehicle ahead.

Warning: Traffic-Aware Cruise Control can cancel unexpectedly at any time for unforeseen reasons. Always watch the



road in front of you and stay prepared to take appropriate action. It is the driver's responsibility to be in control of Model X at all times.

Summary of Cruise Indicators



Traffic-Aware Cruise Control is available but is not actively controlling your speed until you activate it. The number shown in gray is determined by Speed Assist (see [Controlling Speed Assist](#) on page 109).



Traffic-Aware Cruise Control is operating and is either maintaining the set speed (no vehicle in front) or is maintaining a chosen following distance from a vehicle ahead (up to the set speed).



Model X has fully stopped but is in a **HOLD** state. If safe, press the accelerator pedal to resume cruising at the set speed.

Limitations

Traffic-Aware Cruise Control is particularly unlikely to operate as intended in the following types of situations:

- The road has sharp curves.
- Visibility is poor (due to heavy rain, snow, fog, etc.).
- Bright light (such as from oncoming headlights or direct sunlight) is interfering with the view of the camera(s).
- The radar sensor is obstructed (dirty, covered, etc.).
- The windshield is obstructing the view of the camera(s) (fogged over, dirty, covered by a sticker, etc.).

 **Warning:** The list above does not represent an exhaustive list of situations that may interfere with proper operation of Traffic-Aware Cruise Control.



Note: Autosteer is a BETA feature.

If you have purchased the optional Enhanced Autopilot or Full Self-Driving Capability packages, you can use Autosteer to manage steering and speed under certain circumstances. Autosteer builds upon Traffic-Aware Cruise Control (see [Traffic-Aware Cruise Control](#) on page 87), intelligently keeping Model X in its driving lane when cruising at a set speed. Using the vehicle's camera(s), the radar sensor, and the ultrasonic sensors, Autosteer detects lane markings and the presence of vehicles and objects, steering Model X based on the lane markings and the vehicle directly in front of you.

- ⚠ Warning:** Autosteer is a hands-on feature. You must keep your hands on the steering wheel at all times.
- ⚠ Warning:** Autosteer is intended for use only on highways and limited-access roads with a fully attentive driver. When using Autosteer, hold the steering wheel and be mindful of road conditions and surrounding traffic. Do not use Autosteer on city streets, in construction zones, or in areas where bicyclists or pedestrians may be present. Never depend on Autosteer to determine an appropriate driving path. Always be prepared to take immediate action. Failure to follow these instructions could cause damage, serious injury or death.

Operating Autosteer

Before you can operate Autosteer, you must enable it by touching **Controls** > **Settings** > **Driver Assistance** > **Autosteer** > **ON**.



To indicate that Autosteer is available (but not actively steering Model X), the instrument panel displays a gray Autosteer icon on the right side of the driving speed.

To initiate Autosteer, pull the cruise control lever toward you twice in quick succession.

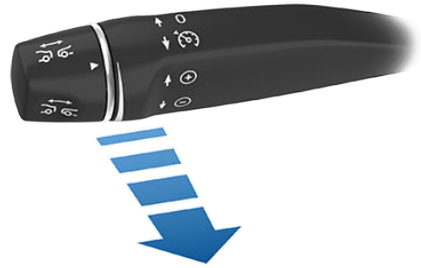

Autosteer briefly displays a message on the instrument panel reminding you to pay attention to the road and be ready to take over at any time. To indicate that Autosteer is now actively steering Model X, the instrument panel displays the Autosteer icon in blue. When Autosteer is able to detect lane markings, it also displays the driving lane in blue.



Note: To initiate Autosteer when there is no vehicle in front of you, you must be driving at least 18 mph (30 km/h) on a roadway with visible lane markings. If a vehicle is detected ahead of you, you can initiate Autosteer at any speed, even when stationary (if you are at least 5 feet (150 cm) away from the vehicle).

The instrument panel displays a message indicating that Autosteer is temporarily unavailable if you attempted to engage Autosteer when driving at a speed that is not within the speed required for Autosteer to operate. Autosteer may also be unavailable if it is not receiving adequate data from the camera(s) or sensors.



If Autosteer is unable to detect lane markings, the driving lane is determined based on the vehicle you are following.

In most cases, Autosteer attempts to center Model X in the driving lane. However, if the sensors detect the presence of an obstacle (such as a vehicle or guard rail), Autosteer may steer Model X in a driving path that is offset from the center of the lane.

Warning: Autosteer is not designed to, and will not, steer Model X around objects partially or completely in the driving lane. Always watch the road in front of you and stay prepared to take appropriate action. It is the driver's responsibility to be in control of Model X at all times.

Restricted Speed

Autosteer is intended for use only by a fully attentive driver on freeways and highways where access is limited by entry and exit ramps. If you choose to use Autosteer on residential roads, a road without a center divider, or a road where access is not limited, Autosteer may limit the maximum allowed cruising speed. The maximum allowed cruising speed on such roads is calculated based on the detected speed limit including a Speed Assist offset of up to +5 mph (10 km/h). Any Speed Assist offset above +5 mph (10 km/h) is rounded down to +5 mph (10 km/h). However, you can select a more restrictive cruising speed by reducing the speed limit offset (see [Controlling Speed Assist](#) on page 109) or by adjusting the cruise control lever.

In situations where the speed limit cannot be detected when Autosteer is engaged, Autosteer reduces your driving speed and limits the set speed to 45 mph (70 km/h). Although you can manually accelerate to exceed the limited speed, Model X may not brake for detected obstacles. Autosteer will slow down to the limited speed when you release the accelerator pedal. When you leave the road, or disengage Autosteer by using the steering wheel, you can increase your set speed again, if desired.

Hold Steering Wheel

Autosteer uses data from the camera(s), sensors, and GPS to determine how best to steer Model X. When active, Autosteer requires you to hold the steering wheel. If it does not detect your hands on the steering wheel for a period of time, a flashing white light appears around the instrument panel and the following message displays:

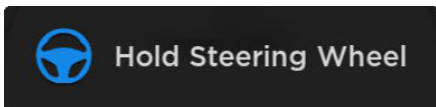

Autosteer detects your hands by recognizing light resistance as the steering wheel turns, or from you manually turning the steering wheel very lightly (i.e., without enough force to retake control). When your hands are detected, the message disappears and Autosteer resumes normal operation.

Note: Autosteer may also sound a chime at the same time that the message is initially displayed.

Autosteer requires that you pay attention to your surroundings and remain prepared to take control at any time. If Autosteer still does not detect your hands on the steering wheel, the request escalates by sounding chimes that increase in frequency.

If you repeatedly ignore hands-on prompts, Autosteer displays the following message and is disabled for the rest of the drive. If you don't resume manual steering, Autosteer sounds a continuous chime, turns on the warning flashers, and slows the vehicle to a complete stop.

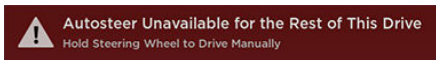

For the rest of the drive, you must steer manually. Autosteer is available again after you stop and shift the vehicle into Park.

Take Over Immediately

In situations where Autosteer is unable to steer Model X, Autosteer sounds a warning chime and displays the following message on the instrument panel:

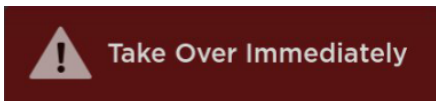



When you see this message, **TAKE OVER STEERING IMMEDIATELY.**

Canceling Autosteer

Autosteer cancels when:

- You start steering manually.
- You press the brake pedal.
- You push the cruise control lever away from you.
- The maximum speed that Autosteer supports—90 mph (150 km/h)—is exceeded.
- You shift into a different gear.
- An Automatic Emergency Braking event occurs (see [Collision Avoidance Assist](#) on page 105).

When Autosteer cancels, it sounds chimes and the Autosteer icon either turns gray to indicate that Autosteer is no longer active, or disappears to indicate that it is not currently available.

Note: If Autosteer cancels because you started steering manually, Traffic-Aware Cruise Control remains active. Disengage Traffic-Aware Cruise Control as you normally would, by briefly pushing the cruise control lever away from you or pressing the brake pedal.

To disable Autosteer so it is no longer available, touch **Controls > Settings > Driver Assistance > Autosteer > OFF.**

Limitations

Autosteer is particularly unlikely to operate as intended when:

- Autosteer is unable to accurately determine lane markings. For example, lane markings are excessively worn, have visible previous markings, have been adjusted due to road construction, are changing quickly (lanes branching off, crossing over, or merging), objects or landscape features are casting strong shadows on the lane markings, or the road surface contains pavement seams or other high-contrast lines.
- Visibility is poor (heavy rain, snow, fog, etc.).
- A camera(s) or sensor(s) is obstructed, covered, or damaged.
- Driving on hills.
- Approaching a toll booth.
- Driving on a road that has sharp curves or is excessively rough.

- Bright light (such as direct sunlight) is interfering with the view of the camera(s).
- The sensors are affected by other electrical equipment or devices that generate ultrasonic waves.

Warning: Many unforeseen circumstances can impair the operation of Autosteer. Always keep this in mind and remember that as a result, Autosteer may not steer Model X appropriately. Always drive attentively and be prepared to take immediate action.



Warning: Auto Lane Change is designed to be used only when driving on restricted-access highways (i.e. with on-ramps and off-ramps).

If you have purchased the optional Enhanced Autopilot or Full Self-Driving Capability packages, you can use Auto Lane Change to move Model X into an adjacent lane without moving the steering wheel (which would cancel Autosteer). When both Traffic-Aware Cruise Control and Autosteer are active, Auto Lane Change intelligently steers Model X into an adjacent driving lane. Using the forward looking camera(s), the radar sensor, and ultrasonic sensors, Model X detects lane markings and the presence of other vehicles.

Auto Lane Change is designed for use on restricted-access highways with visible lane markings and under relatively predictable circumstances in which minimal steering and driver intervention is needed.

Warning: It is the driver's responsibility to determine whether a lane change is safe and appropriate. Auto Lane Change cannot detect oncoming traffic in the target lane, especially fast moving vehicles from the rear. Therefore, before initiating a lane change, always check blind spots, lane markings, and the surrounding roadway to confirm it is safe and appropriate to move into the target lane.

Warning: Never depend on Auto Lane Change to determine an appropriate driving path. Drive attentively by watching the road and traffic ahead of you, checking the surrounding area, and monitoring the instrument panel for warnings. Always be prepared to take immediate action.

Warning: Do not use Auto Lane Change on city streets or on roads where traffic conditions are constantly changing and where bicycles and pedestrians are present.

Warning: The performance of Auto Lane Change depends on the ability of the camera(s) to recognize lane markings.

Warning: Do not use Auto Lane Change on winding roads with sharp curves, on icy or slippery roads, or when weather conditions (such as heavy rain, snow, fog, etc.) may be obstructing the view from the camera(s) or sensors.

Warning: Failure to follow all warnings and instructions can result in serious property damage, injury or death.

Operating Auto Lane Change

Before you can operate Auto Lane Change, you must enable it by touching **Controls > Settings > Driver Assistance > Auto Lane Change > ON**.

Note: Before you can turn on Auto Lane Change, you must turn on Autosteer (see [Autosteer](#) on page 93). Without Autosteer, Auto Lane Change cannot operate.

Note: Your chosen setting is retained until you manually change it. It is also saved in your driver profile.

To change lanes using Auto Lane Change:

1. Perform visual checks to make sure it is safe and appropriate to move into the target lane.
2. Engage the appropriate turn signal.
3. Disengage the turn signal after you are in the target lane.

Auto Lane Change moves Model X into the adjacent lane in the direction indicated by the turn signal, provided the following conditions are met:

- The Auto Lane Change setting is turned on.
- The turn signal is engaged.
- Autosteer is actively steering Model X.
- The ultrasonic sensors do not detect a vehicle or obstacle up to the center of the target lane.
- The lane markings indicate that a lane change is permitted.
- The view of the camera(s) is not obstructed.
- Lane Assist does not detect a vehicle in the blind spot (see [Lane Assist](#) on page 103).
- Midway through the lane change, Auto Lane Change can detect the outside lane marking of the target lane.
- Driving speed is at least 30 mph (45 km/h).



As the lane change is in progress, Overtake Acceleration is activated, allowing Model X to accelerate closer to a vehicle in front (see [Overtake Acceleration](#) on page 90). Midway through the lane change, Auto Lane Change must be able to detect the target lane's outside lane marking. If this lane marking cannot be detected, both Auto Lane Change and Autosteer will cancel.

Note: Auto Lane Change moves Model X one lane at a time. Moving into an additional lane requires you to engage the turn signal a second time after the first lane change is complete.

Warning: If Auto Lane Change aborts during a lane change (for example, Auto Lane Change cannot detect the outside of the target lane midway through the lane change), Model X returns to its original driving lane.

When Auto Lane Change is active, it is important to monitor its performance by watching the driving path in front of you and the surrounding area. Stay prepared to take over steering at any time. As you are crossing over into the adjacent lane, the instrument panel displays the lane marking as a dashed blue line. Once in your new lane, lane markings are displayed as solid blue lines again.

In situations where Auto Lane Change is unable to operate at optimal performance, or cannot operate due to inadequate data, the instrument panel displays a series of warnings. Therefore, when using Auto Lane Change, always pay attention to the instrument panel and be prepared to manually steer Model X.

Warning: When Auto Lane Change is actively steering Model X, the steering wheel moves accordingly. Any significant restriction of or force on the steering wheel's movement can cancel both Auto Lane Change and Autosteer.

Canceling Auto Lane Change

Auto Lane Change cancels when you manually move the steering wheel, press the brake pedal, or disengage the turn indicator before Model X crosses the markers on the existing lane.

To disable Auto Lane Change so it is no longer available, touch **Controls** > **Settings** > **Driver Assistance** > **Auto Lane Change** > **OFF**.

Limitations

Auto Lane Change is particularly unlikely to operate as intended in the following types of situations:

- Auto Lane Change is unable to accurately determine lane markings. For example, lane markings are excessively worn, have visible previous markings, have been adjusted due to road construction, are changing quickly (lanes branching off, crossing over, or merging), objects or landscape features are casting strong shadows on the lane markings, or the road surface contains pavement seams or other high-contrast lines.
- A vehicle is detected in your blind spot when you engage the turn signal.
- The road has sharp curves.
- Visibility is poor (due to heavy rain, snow, fog, etc.) or weather conditions are interfering with sensor operation.
- Bright light (oncoming headlights or direct sunlight) is interfering with the view of the camera(s).
- A sensor or camera is damaged or obstructed (such as by mud, fog, ice, snow, etc.).
- The sensors are affected by other electrical equipment or devices that generate ultrasonic waves.
- Model X is being driven very close to a vehicle in front of it, which is blocking the view of the camera(s).

Warning: Many unforeseen circumstances can impair the operation of Auto Lane Change. Always keep this in mind and remember that as a result, Auto Lane Change may not steer Model X appropriately. Always drive attentively and stay prepared to immediately take action at any time.



If you have purchased the optional Enhanced Autopilot or Full Self-Driving Capability package, Autopark uses data from the ultrasonic sensors and GPS to:

- Simplify parking on public roads by maneuvering Model X into parallel and perpendicular parking spaces. See [Parking on Public Roads](#) on page 98.
- Automatically park and retrieve Model X from outside the vehicle on a private residential property. See [Using Summon](#) on page 99.

Warning: Summon is a BETA feature. Please use this feature with caution, staying prepared to take immediate action at any time.

Warning: Autopark's performance depends on the ability of the ultrasonic sensors to determine the vehicle's proximity to curbs, objects, and other vehicles.

Parking on Public Roads

When driving, follow these steps to allow Autopark to maneuver Model X into a parking space:

1. When driving slowly on a public road, monitor the instrument panel to determine when Autopark has detected a parking space. When Autopark detects a potential parking space, the instrument panel displays a parking icon. Autopark detects parallel parking locations when driving below 15 mph (24 km/h) and perpendicular parking locations when driving below 10 mph (16 km/h).



Note: The parking icon appears only if the vehicle's position and/or the circumstances of the surrounding area are such that Autopark can determine an appropriate driving path. If Autopark cannot determine an appropriate path (for example, when driving on a narrow street where moving into the parking space causes the front of the vehicle to extend into the adjacent lane), you can either reposition the vehicle, find a different parking space, or park manually.

2. Check to determine if the detected parking space is appropriate and safe. If so, pull forward and stop approximately a car length ahead of the parking space (as you normally would when parallel parking or when backing into a perpendicular parking space).
3. Release the steering wheel, shift Model X into Reverse, then touch **Start Autopark** on the touchscreen.
4. When parking is complete, Autopark displays the "Complete" message.

In situations where Autopark cannot operate due to inadequate sensor data, the instrument panel displays a message indicating that you must manually park Model X.

Note: If you press the brake when Autopark is actively parking Model X, the parking process pauses until you touch **Resume** on the touchscreen.

Note: Autopark detects potential perpendicular parking spaces that are at least 9.5 feet (2.9 meters) wide with a vehicle parked on each side. Autopark detects parallel parking spaces that are at least 20 feet (6 meters), but less than 30 feet (9 meters) long. Autopark does not operate on angled parking spaces.

Warning: Never depend on Autopark to find a parking space that is legal, suitable, and safe. Autopark may not always detect objects in the parking space. Always perform visual checks to confirm that a parking space is appropriate and safe.

Warning: When Autopark is actively steering Model X, the steering wheel moves in accordance with Autopark's adjustments. Do not interfere with the movement of the steering wheel. Doing so cancels Autopark.

Warning: During the parking sequence, continually check your surroundings. Be prepared to apply the brakes to avoid vehicles, pedestrians, or objects.

Warning: When Autopark is active, monitor the touchscreen and instrument panel to ensure that you are aware of the instructions that Autopark is providing.

To Pause Parking

To pause Autopark, press the brake pedal once. Model X stops and remains stopped until you touch **Resume** on the touchscreen.



To Cancel Parking

Autopark cancels the parking sequence when you manually move the steering wheel, change gears, or touch **Cancel** on the touchscreen. Autopark also cancels parking when:

- The parking sequence exceeds the maximum of seven moves.
- Model X detects that the driver is exiting the vehicle.
- A door is opened.
- You press the accelerator pedal.
- You press the brake pedal while Autopark is paused.
- An Automatic Emergency Braking event occurs (see [Collision Avoidance Assist](#) on page 105).

Limitations

Autopark is particularly unlikely to operate as intended in these situations:

- The road is sloped. Autopark is designed to operate on flat roads only.
- Visibility is poor (due to heavy rain, snow, fog, etc.).
- The curb is constructed of material other than stone, or the curb cannot be detected.
- The target parking space is directly adjacent to a wall or pillar (for example, the last parking space of a row in an underground parking structure).
- One or more of the ultrasonic sensors is damaged, dirty, or obstructed (such as by mud, ice, or snow).
- Weather conditions (heavy rain, snow, fog, or extremely hot or cold temperatures) are interfering with sensor operation.
- The sensors are affected by other electrical equipment or devices that generate ultrasonic waves.

⚠ Warning: Many unforeseen circumstances can impair Autopark's ability to park Model X. Keep this in mind and remember that as a result, Autopark may not steer Model X appropriately. Pay attention when parking Model X and stay prepared to immediately take control.

Using Summon

Note: Summon is a BETA feature. Summon is designed and intended for use only on a private residential property where the surrounding area is familiar and predictable. When using Summon, you must continually monitor the vehicle. It is the driver's responsibility to use this feature safely, responsibly, and as intended.

With Summon, you can move Model X in and out of a parking space from outside the vehicle using the mobile app or the key. You can also customize Summon to park or retrieve Model X with a single touch of a button and to initiate parking automatically after you double-press the Park gear and exit the vehicle. Using data from the ultrasonic sensors, Summon maneuvers Model X forward or reverse into a parking space. When parking is complete Summon shifts Model X into Park. Parking is complete when:

- Model X detects an obstacle in its driving path (within a chosen distance)
- Summon has moved Model X the maximum distance of 39 feet (12 meters) OR
- In the case of reversing, Summon has reached the maximum **Summon Distance**.

To use Summon:

- **FIRST TIME ONLY:** Enable Summon and customize how it works (see [Customizing Summon](#) on page 100).
- Position Model X for parking (see [Position the Vehicle for Parking](#) on page 100).
- Initiate the parking maneuver using the mobile app, the key, or by double-pressing the Park gear. Detailed instructions for each method are provided later.

You can summon Model X back to its original position if you previously auto parked it and the vehicle has remained in the Park gear. Then, using the mobile app or key, simply specify the opposite direction. Summon moves the vehicle along the original path provided the environment has not changed (i.e. no obstructions have been introduced). If obstacles are detected, Summon attempts to avoid the obstacles while staying as close as possible to its original path.

To cancel Summon and stop Model X at any time during a parking maneuver, use the mobile app, press any button on the key, or (if sitting in the vehicle) interact with the steering wheel, brake pedal, accelerator pedal, or gear stalk.



Note: If you want Summon to move multiple times in the same direction, up to the maximum of 39 feet (12 meters), cancel Summon and then re-initiate the parking process, choosing the same direction.

Note: Summon can move Model X a short distance laterally to avoid an obstacle but in doing so, does not return the vehicle to its driving path (i.e. Summon does not attempt to move Model X around an obstacle).

Warning: Summon is unable to operate as intended if the ultrasonic sensors are obstructed by a vehicle bra, excessive paint, or adhesive products (such as wraps, stickers, rubber coating, etc.).

Warning: Model X cannot detect obstacles that are located lower than the bumper, very narrow (i.e. bicycles), or hanging from a ceiling. In addition, many unforeseen circumstances can impair Summon's ability to move in or out of a parking space and as a result, Summon may not appropriately steer Model X. Therefore, you must continually monitor the vehicle's movement and surroundings and remain prepared to stop Model X at any time.

Customizing Summon

Before operating Summon, use the touchscreen to enable it. Touch **Controls > Settings > Driver Assistance > Summon > ON**.

Then touch **Customize** to specify how Summon operates whenever it parks or retrieves your vehicle:

- **Bumper Clearance:** Set the distance that you want Summon to stop from a detected object. For example, you may want Summon to stop within just a few inches of the garage wall. This distance applies only to objects detected directly in front of (when moving forward) or behind (when reversing) Model X.
- **Summon Distance:** Specify the distance Model X travels when backing out of a parking space.
- **Side Clearance:** Allow Model X to enter and exit very narrow parking spaces.

Warning: Parking in a narrow space limits the ability of the sensors to accurately detect the location of obstacles, increasing the risk of damage to Model X and/or surrounding objects.

- **Require Continuous Press (U.S. Only):** By default, Summon requires that you press and hold a button on the mobile app to move the vehicle during the parking process. When you set Require Continuous Press to **NO**, you can:
 - Park Model X by simply double pressing the Park gear, specifying the direction on the touchscreen (if reversing), then exiting the vehicle.
 - Park or retrieve Model X with a single touch of a button on the mobile app.
 - Park or retrieve Model X using the key.
- **Use Auto HomeLink (if equipped):** Set to **ON** if you want to activate HomeLink to open/close a programmed garage door that meets safety standards during the parking process. If enabled, the garage door automatically opens and closes when Model X enters or exits.

Note: This setting automatically opens and closes the garage door only when using Summon. To automate HomeLink in other situations (such as when driving), you must access the HomeLink device's main settings by touching **Controls > Settings > HomeLink** (see [HomeLink Universal Transceiver](#) on page 145).

Warning: Do not use this setting with gates or with a garage door that does not meet safety standards. A garage door opener that does not have safety stop and reverse features (cannot detect an object in its path and then automatically stop and reverse) does not meet these standards. Using a garage door opener without these features increases the risk of injury or death.

Note: All settings associated with Summon are retained until you manually change them.

Position the Vehicle for Parking

Before operating Summon, align Model X laterally with the parking space so Model X can move straight into the space in either Drive or Reverse. You must also position Model X within 39 feet (12 meters) of the parking space (the maximum distance that Summon can move Model X).

If applicable, open your garage door. As described earlier, this can be automated using Auto HomeLink (if equipped).



Note: Use Summon on flat driveways only where a raised concrete edge does not exceed approximately 1 in (2.5 cm).

Operating Summon with the Mobile App

On the mobile app, start Summon and hold down the forward or reverse button to move Model X into the parking space. (U.S. Only): If **Require Continuous Press** is set to **NO** (see [Customizing Summon](#) on page 100), you do not need to hold down the button, just touch and release.

Summon shifts Model X into Drive or Reverse (based on the direction you specified) and drives into the parking space.

Note: Summon cancels if your phone enters sleep mode or is turned off.

Operating Summon with the Key (U.S. Only)

Note: To operate Summon with the key, **Require Continuous Press** must be set to **NO** (see [Customizing Summon](#) on page 100).

Note: It may not be possible to operate Summon with the key if the key's battery is low.

Follow these steps to park Model X from outside the vehicle using the key:

1. With Model X in Park, stand within 10 feet (3 meters) and press and hold the top center button on the key (Lock/Unlock All button) until the hazard lights blink continuously.

Note: The hazard lights flash once as Model X locks, then within five seconds, Model X powers on and the hazard lights flash continuously. Do not proceed to the next step until the hazard lights are flashing. If, after five seconds, the hazard lights are not flashing, release the button on the key, move closer to Model X, and try again. If Summon receives no further input within ten seconds, Summon cancels.

2. Press the Front Trunk (Frunk) button on the key to move Model X forward into the parking space, or press the Rear Trunk button to reverse Model X into the parking space.

Initiate Automatic Parking Before Exiting the Vehicle (U.S. Only)

If **Require Continuous Press** is set to **NO**, you can initiate the parking maneuver from inside Model X before exiting:

1. While sitting in Model X with the vehicle powered on, double press the Park gear. The instrument panel displays a message indicating that Summon is engaged, and the touchscreen displays a popup window.
2. On the touchscreen, choose the direction of travel.
3. Exit Model X and close the door.

Note: All doors and trunks must be closed.

Note: To cancel the parking maneuver before exiting the vehicle, touch **Cancel** on the popup window.

Note: If no direction of travel was selected on the touchscreen, Model X will not attempt the parking maneuver after you exit the vehicle.

Summon now drives Model X into the parking space according to the direction you specified on the touchscreen.

Stopping or Canceling Summon

You can stop Model X at any time while Summon is active by pressing any button on the key or by using the mobile app. Summon also cancels when:

- A door handle is pressed or a door is opened.
- You interact with the steering wheel, brake pedal, accelerator pedal, or gear stalk.
- Model X detects an obstacle and cannot move forward for more than approximately two seconds.
- Summon has moved Model X the maximum distance of approximately 39 feet (12 meters).

Limitations

Summon is unlikely to operate as intended in the following types of situations:

- The road is sloped. Summon is designed to operate on flat roads only.
- Summon has detected a raised concrete edge when moving forward into the parking location. Summon does not drive forward over an edge that is higher than approximately 1 in (2.5 cm).
- One or more of the ultrasonic sensors is damaged, dirty, or obstructed (such as by mud, ice, or snow).
- Weather conditions (heavy rain, snow, fog, or extremely hot or cold temperatures) are interfering with sensor operation.



- The sensors are affected by other electrical equipment or devices that generate ultrasonic waves.
- Model X is in Trailer Mode or an accessory is attached.

Note: Summon is disabled if Model X is in Valet mode (see [Valet Mode](#) on page 43).

Warning: The list above does not represent an exhaustive list of situations that may interfere with proper operation of Autopark's Summon feature. It is the driver's responsibility to remain in control of Model X at all times. Pay close attention whenever Summon is actively moving Model X and stay prepared to take immediate action. Failure to do so can result in serious property damage, injury or death.



The cameras monitor the markers on the lane you are driving in and the ultrasonic sensors monitor the surrounding areas and the blind spot for the presence of a vehicle or other objects.

When an object is detected in your blind spot or close to the side of Model X (such as a vehicle, guard rail, etc.), colored lines radiate from the image of Model X on the instrument panel. The location of the lines correspond to the location of the detected object. The color of the lines (white, yellow, orange, or red) represents the object's proximity to Model X, with white being the farthest and red being very close and requiring your immediate attention. These colored lines only display when driving between approximately 7 and 85 mph (12 and 140 km/h). When Autosteer is active, these colored lines also display if driving slower than 7 mph (12 km/h). However, the colored lines do not display if Model X is at a standstill (for example, in heavy traffic).



Lane Assist also warns you of undesired lane departures by vibrating the steering wheel slightly if a front wheel passes over a lane marking and the associated turn signal is off. This warning is active only when driving between approximately 36 and 90 mph (59 and 150 km/h). To turn this warning on or off, touch **Controls > Settings > Driver Assistance > Lane Departure Warning**. Your chosen setting is retained until you manually change it. It is also saved in your driver profile.

In addition to the warnings previously described, Lane Assist may provide steering interventions if Model X drifts into (or close to) an adjacent lane in which an object, such as a vehicle, is detected. In these situations, Model X automatically steers to a safer position in its driving lane. This steering is applied only when Model X is traveling between 30 and 85 mph (48 and 140 km/h) on major roadways with clearly visible lane markings. When Lane Assist applies a steering intervention, the instrument panel briefly displays a warning message.

- ⚠ Warning:** Steering interventions are minimal and are not designed to move Model X out of its driving lane. Do not rely on steering interventions to avoid side collisions.
- ⚠ Warning:** Lane Assist features are for guidance purposes only and are not intended to replace your own direct visual checks. Never depend on Lane Assist to inform you of unintentionally driving outside of the boundaries of the driving lane or informing you that an object or vehicle is in your blind spot or close to the side of your vehicle. Several external factors can reduce the performance of Lane Assist. It is the driver's responsibility to stay alert, pay attention to the driving lane and always be aware of other road users. Failure to do so can result in serious injury or death.
- ⚠ Warning:** Lane Assist is designed to detect lane markings and may not detect the edge of a road, especially if the road has no curb. It is the driver's responsibility to drive attentively and stay within the boundaries of the driving lane.
- ⚠ Warning:** Before changing lanes, always visually check the lane you are moving into by using side mirrors and performing the appropriate shoulder checks. Several factors can affect the performance of the Lane Assist warnings, resulting in lack of, or false warnings (see [Limitations and Inaccuracies](#) on page 103).

Limitations and Inaccuracies

Lane Assist cannot always clearly detect lane markings and you may experience unnecessary or invalid warnings in these situations:



- Visibility is poor and lane markings are not clearly visible (due to heavy rain, snow, fog, etc.). The exact detection zone of the ultrasonic sensors varies depending on environmental conditions.
- Bright light (such as from oncoming headlights or direct sunlight) is interfering with the view of the camera(s).
- A vehicle in front of Model X is blocking the view of the camera(s).
- The windshield is obstructing the view of the camera(s) (fogged over, dirty, covered by a sticker, etc.).
- Lane markings are excessively worn, have visible previous markings, have been adjusted due to road construction, or are changing quickly (for example, lanes branching off, crossing over, or merging).
- The road is narrow or winding.
- Objects or landscape features are casting strong shadows on lane markers.
- One or more of the ultrasonic sensors is damaged, dirty, or obstructed (such as by mud, ice, or snow).
- Weather conditions (heavy rain, snow, fog, or extremely hot or cold temperatures) are interfering with sensor operation.
- The sensors are affected by other electrical equipment or devices that generate ultrasonic waves.
- An object mounted to Model X (such as a bike rack or a bumper sticker) is interfering with or obstructing a sensor.
- Visibility is poor and lane markings are not clearly visible (due to heavy rain, snow, fog, etc.).
- Lane markings are excessively worn, have visible previous markings, have been adjusted due to road construction or are changing quickly (for example, lanes branching off, crossing over, or merging).

Lane Assist may not provide warnings, or may apply inappropriate warnings, in these situations:

- One or more of the ultrasonic sensors is damaged, dirty, or obstructed (such as by mud, ice, or snow).
- Weather conditions (heavy rain, snow, fog, or extremely hot or cold temperatures) are interfering with sensor operation.
- The sensors are affected by other electrical equipment or devices that generate ultrasonic waves.
- An object that is mounted to Model X is interfering with and/or obstructing a sensor (such as a bike rack or a bumper sticker).

In addition, Lane Assist may not steer Model X away from an adjacent vehicle, or may apply unnecessary or inappropriate steering, in these situations:

- You are driving Model X on sharp corners or on a curve at a relatively high speed.
- Bright light (such as from oncoming headlights or direct sunlight) is interfering with the view of the camera(s).
- You are drifting into another lane but an object (such as a vehicle) is not present.
- A vehicle in another lane cuts in front of you or drifts into your driving lane.
- Model X is traveling slower than 30 mph (48 km/h) or faster than 90 mph (145 km/h).

Warning: The lists above do not represent every possible situation that may interfere with Lane Assist warnings. Lane Assist may not operate as intended for many other reasons. To avoid a collision, stay alert and always pay attention to the roadway when driving Model X so you can anticipate the need to take corrective action as early as possible.



The following collision avoidance features are designed to increase the safety of you and your passengers:

- **Forward Collision Warning** - provides visual and audible warnings in situations when Model X detects that there is a high risk of a frontal collision (see [Forward Collision Warning](#) on page 105).
- **Automatic Emergency Braking** - automatically applies braking to reduce the impact of a frontal collision (see [Automatic Emergency Braking](#) on page 106).
- **Pedal Misapplication Mitigation** - may reduce the impact of a collision in situations where Model X detects an object in its immediate driving path and determines that the driver has accidentally pressed the accelerator pedal (see [Pedal Misapplication Mitigation](#) on page 107).

Warning: Forward Collision Warning is for guidance purposes only and is not a substitute for attentive driving and sound judgment. Keep your eyes on the road when driving and never depend on Forward Collision Warning to warn you of a potential collision. Several factors can reduce or impair performance, causing either unnecessary, invalid, inaccurate, or missed warnings. Depending on Forward Collision Warning to warn you of a potential collision can result in serious injury or death.

Warning: Automatic Emergency Braking is not designed to prevent a collision. At best, it can minimize the impact of a frontal collision by attempting to reduce your driving speed. Depending on Automatic Emergency Braking to avoid a collision can result in serious injury or death.

Warning: Pedal Misapplication Mitigation is not designed to prevent a collision. At best, it can minimize the impact of a collision. Depending on Pedal Misapplication Mitigation to avoid a collision can result in serious injury or death.

Forward Collision Warning

The forward looking camera(s) and the radar sensor monitor the area in front of Model X for the presence of an object such as a vehicle, bicycle, or pedestrian. If a collision is considered likely unless you take immediate corrective action, Forward Collision Warning is designed to sound a chime and highlight the vehicle in front of you in red on the instrument panel. If this happens, **TAKE IMMEDIATE CORRECTIVE ACTION!**

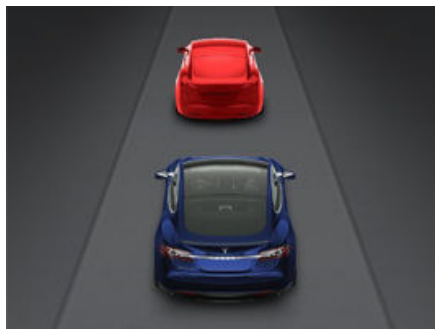

Warnings cancel automatically when the risk of a collision has been reduced (for example, you have decelerated or stopped Model X, or the object in front of your vehicle has moved out of your driving path).

If immediate action is not taken when Model X issues a Forward Collision Warning, Automatic Emergency Braking (if enabled) may automatically apply the brakes if a collision is considered imminent (see [Automatic Emergency Braking](#) on page 106).

By default, Forward Collision Warning is turned on. To turn it off or adjust its sensitivity, touch **Controls > Settings > Driver Assistance > Forward Collision Warning**. Instead of the default warning level of **Medium**, you can turn the warning **Off**, or you can choose to be warned **Late** or **Early**.

Note: Your chosen setting for Forward Collision Warning is retained until you manually change it. It is also saved in your driver profile.

Warning: The camera(s) and sensors associated with Forward Collision Warning are designed to monitor an approximate area of up to 525 feet (160 meters) in your driving path. The area being monitored by Forward Collision Warning can be adversely



affected by road and weather conditions. Use appropriate caution when driving.

Warning: Forward Collision Warning is designed only to provide visual and audible alerts. It does not attempt to apply the brakes or decelerate Model X. When seeing and/or hearing a warning, it is the driver's responsibility to take corrective action immediately.

Warning: Forward Collision Warning may provide a warning in situations where the likelihood of collision may not exist. Stay alert and always pay attention to the area in front of Model X so you can anticipate whether any action is required.

Warning: Forward Collision Warning operates only when driving between approximately 7 mph (10 km/h) and 90 mph (150 km/h).

Warning: Forward Collision Warning does not provide a warning when the driver is already applying the brake.

Automatic Emergency Braking

The forward looking camera(s) and the radar sensor are designed to determine the distance from an object (vehicle, motorcycle, bicycle, or pedestrian) traveling in front of Model X. When a frontal collision is considered unavoidable, Automatic Emergency Braking is designed to apply the brakes to reduce the severity of the impact.

When Automatic Emergency Braking applies the brakes, the instrument panel displays a visual warning and sounds a chime. You may also notice abrupt downward movement of the brake pedal. The brake lights turn on to alert other road users that you are slowing down.

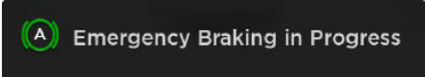

If driving 29 mph (46 km/h) or faster, the brakes are released after Automatic Emergency Braking has reduced your driving speed by 25 mph (40 km/h). For example, if Automatic Emergency Braking applies braking when driving 56 mph (90 km/h), it releases the brakes when your speed has been reduced to 31 mph (50 km/h).

Automatic Emergency Braking operates only when driving between approximately 7 mph (10 km/h) and 90 mph (150 km/h).

Automatic Emergency Braking does not apply the brakes, or stops applying the brakes, when:

- You turn the steering wheel sharply.
- You press and release the brake pedal while Automatic Emergency Braking is applying the brakes.
- You accelerate hard (the pressure on the accelerator pedal increases from below 90% to above 90%) while Automatic Emergency Braking is applying the brakes.
- The vehicle, motorcycle, bicycle, or pedestrian is no longer detected ahead.

Automatic Emergency Braking is always enabled when you start Model X. To disable it (in addition to disabling Pedal Misapplication Mitigation) for your current drive, touch **Controls > Settings > Driver Assistance > Automatic Emergency Braking > Disable**.

Warning: Disabling Automatic Emergency Braking also disables Pedal Misapplication Mitigation.

Warning: It is strongly recommended that you do not disable Automatic Emergency Braking. If you disable it, Model X does not automatically apply the brakes in situations where a collision is considered likely.

Warning: Automatic Emergency Braking is designed to reduce the severity of an impact. It is not designed to avoid a collision.

Warning: Several factors can affect the performance of Automatic Emergency Braking, causing either no braking or inappropriate or untimely braking. It is the driver's responsibility to drive safely and remain in control of the vehicle at all times. Never depend on Automatic Emergency Braking to avoid or reduce the impact of a collision.

Warning: Automatic Emergency Braking is designed to reduce the impact of frontal collisions only and does not function when Model X is in Reverse.

Warning: Automatic Emergency Braking is not a substitute for maintaining a safe traveling distance between you and the vehicle in front of you.

Warning: The brake pedal moves downward abruptly during automatic braking events. Always ensure that the brake pedal can move freely. Do not place material under or on top of the Tesla-



supplied driver's floor mat (including an additional mat) and always ensure that the driver's floor mat is properly secured. Failure to do so can impede the ability of the brake pedal to move freely.

Note: For advance notice of an Automatic Emergency Braking event, turn on Forward Collision Warning (see [Forward Collision Warning](#) on page 105). When turned on, you hear a chime and see a collision warning on the instrument panel if a collision is considered likely. Then, if you do not take immediate corrective action, a collision is considered imminent and Automatic Emergency Braking applies braking to reduce driving speed. If enabled, Automatic Emergency Braking applies braking when a collision is considered inevitable, even if Forward Collision Warning is turned off.

Pedal Misapplication Mitigation

Pedal Misapplication Mitigation is designed to reduce the impact of a collision by reducing motor torque and in some cases, applying the brakes, if Model X detects an object in its driving path and has determined that you have accidentally pressed the accelerator pedal (instead of the brake pedal). For example, Model X, while parked in front of a closed garage door with the Drive gear engaged, detects that you have pressed hard on the accelerator pedal. Although Model X still accelerates and hits the garage door, the reduced torque may result in less damage.

When the torque is reduced, the instrument panel displays:

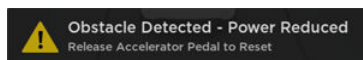

To override this feature and resume normal motor torque (and cancel any automated braking that may be in effect), release and reapply the accelerator pedal.

Pedal Misapplication Mitigation is designed to operate only when all of these conditions are met:

- A driving gear is engaged (Drive or Reverse).
- Model X is stopped or traveling less than 10 mph (16 km/h).
- Model X detects an object in its immediate driving path.
- Pressure on the accelerator pedal pressure exceeds 50%.

Pedal Misapplication Mitigation is enabled whenever Automatic Emergency Braking is enabled (see [Automatic Emergency Braking](#) on page 106).

- ⚠ **Warning:** Pedal Misapplication Mitigation is designed to reduce the severity of an impact. It is not designed to avoid a collision.
- ⚠ **Warning:** Pedal Misapplication Mitigation may not limit torque in all situations. Several factors, including environmental conditions, distance from an obstacle, and a driver's actions, can limit, delay, or inhibit Pedal Misapplication Mitigation.
- ⚠ **Warning:** Do not rely on Pedal Misapplication Mitigation to control acceleration or to avoid, or limit, the severity of a collision, and do not attempt to test Pedal Misapplication Mitigation. Doing so can result in serious property damage, injury, or death.
- ⚠ **Warning:** Several factors can affect the performance of Pedal Misapplication Mitigation, causing an inappropriate or untimely reduction in motor torque and/or undesired braking. It is the driver's responsibility to drive safely and remain in control of Model X at all times.

Limitations and Inaccuracies

Collision Avoidance features cannot always detect all objects, vehicles, bikes, or pedestrians, and you may experience unnecessary, inaccurate, invalid, or missed warnings for many reasons, particularly if:

- The road has sharp curves.
- Visibility is poor (due to heavy rain, snow, fog, etc.).
- Bright light (such as from oncoming headlights or direct sunlight) is interfering with the view of the camera(s).
- The radar sensor is obstructed (dirty, covered, etc.).
- The windshield is obstructing the view of the camera(s) (fogged over, dirty, covered by a sticker, etc.).

- ⚠ **Warning:** The limitations previously described do not represent an exhaustive list of situations that may interfere with proper operation of Collision Avoidance Assist features. These features may fail to provide their intended function for many other reasons. It is the driver's responsibility to avoid collisions by staying alert and paying attention to the



Collision Avoidance Assist

area beside Model X so you can anticipate the need to take corrective action as early as possible.



Caution: If a fault occurs with a Collision Avoidance Assist feature, Model X displays an alert. Contact Tesla Service.



How Speed Assist Works

When the Speed Limit Warning is turned on, the instrument panel displays a speed limit as determined by GPS data. Warnings (described later) take effect when you exceed this limit.

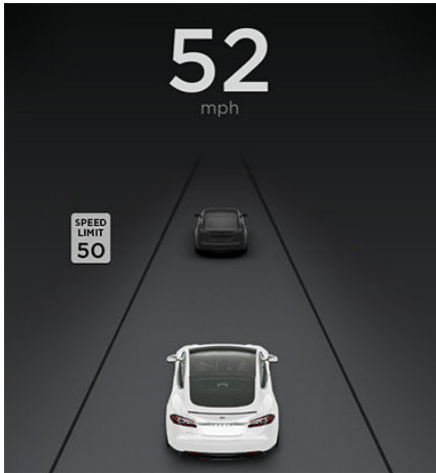

In situations where Speed Assist is unable to determine a speed limit (for example, speed limit signs and GPS data are not available at the current location), or if Speed Assist is uncertain that an acquired speed limit is accurate (for example, although a speed limit sign was initially detected, some time has passed before a subsequent sign has been detected), the instrument panel may not display a speed limit sign and warnings do not take effect.

If you set the speed limit warning to **Display** (see [Controlling Speed Assist](#) on page 109) and exceed the determined speed limit, the speed limit sign on the instrument panel increases in size.

If you set the speed limit warning to **Chime** (see [Controlling Speed Assist](#) on page 109) and exceed the determined speed limit, the speed limit sign on the instrument panel increases in size and Model X also sounds a warning chime.

Note: Speed limit warnings go away after ten seconds, or when Model X slows down below the specified limit.

Warning: Do not rely on Speed Assist to determine the appropriate speed limit or driving speed. Always drive at a safe

speed based on traffic and road conditions.

Controlling Speed Assist

To adjust the Speed Limit Warning setting, touch **Controls** > **Settings** > **Driver Assistance** > **Speed Limit Warning**, then choose one of these options:

- **Off** - Speed limit warnings do not display and chimes are not sounded.
- **Display** - Speed limit signs display on the instrument panel and the sign increases in size when you exceed the determined limit.
- **Chime** - In addition to the visual display, a chime is sounded whenever you exceed the determined speed limit.

You can also specify how the speed limit is determined:

- **Relative** - The speed limit is determined automatically based on detected traffic signs and GPS data. If desired, you can set a speed limit offset (+ or -) if you want to be alerted only when you exceed the offset speed limit by a specified amount. For example, you can increase the offset to +10 mph (10 km/h) if you only want to be warned when you exceed the speed limit by 10 mph (10 km/h).

Note: The offset from speed limit also affects the number shown in the gray speedometer icon on the left side of the driving speed on the instrument panel.

- **Absolute** - Manually specify any speed limit between 20 and 140 mph (30 and 240 km/h).

Note: GPS data is not always accurate. The GPS can miscalculate a road's location and provide the speed limit for a directly adjacent road that may have a different speed limit. For example, the GPS can assume Model X is on a freeway or highway when it is actually on a nearby surface street, and vice versa.

Note: Your chosen setting is retained until you manually change it. It is also saved in your driver profile.

Limitations and Inaccuracies

Speed Assist may not be fully functional or may provide inaccurate information in these situations:

- The speed limits stored in the GPS database are incorrect or outdated.



- Model X is being driven in an area where GPS data is not available.
- A road or a speed limit has recently changed.

 **Warning:** The list above does not represent an exhaustive list of situations that may interfere with proper operation of Speed Assist. Speed Assist may fail to provide warnings for many other reasons.



The Big Picture

The main components of the touchscreen are shown here. To manually control the brightness and contrast, touch **Controls > Displays**. When set to **Auto**, the touchscreen changes between the Day (light background) and Night (dark background) setting depending on ambient lighting conditions.

Note: The following illustration is provided for demonstration purposes only. Depending on vehicle options, software version and market region, your touchscreen may appear slightly different.

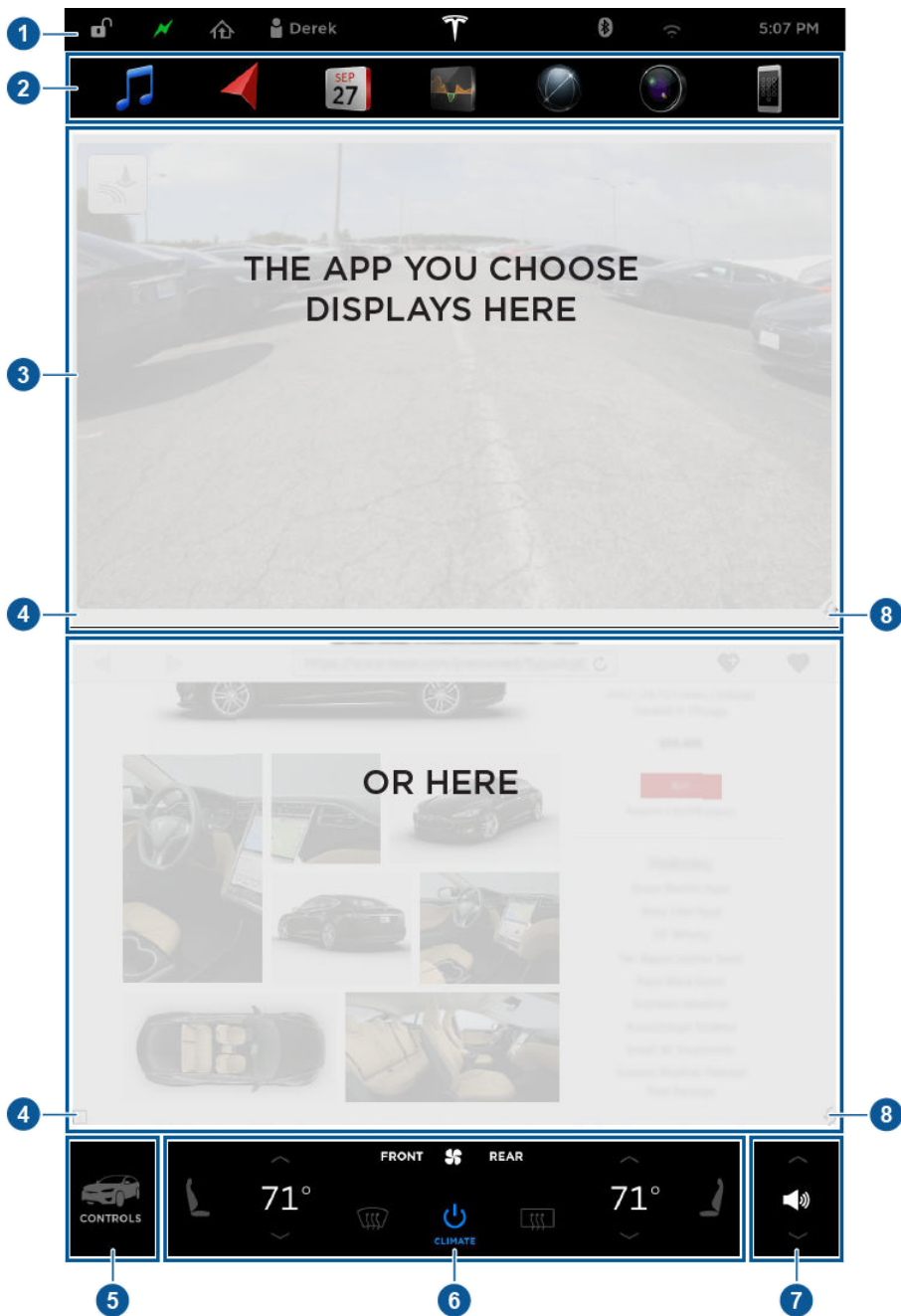



1. Status bar

The top line displays provides shortcuts to lock/unlock Model X, to access HomeLink (if equipped) and Driver Profiles, display vehicle information (the Tesla "T"), download software updates, display network strength and Bluetooth® status and Wi-Fi settings. If an alert icon (exclamation mark) is displayed, touch it to see warning messages that are in effect.

Note: The airbag status symbol displays only when Model X is powered on.

Note: You can also display the time and outside temperature on the instrument panel by choosing the **Clock** option using the left or right scroll wheel on the steering wheel (see [Steering Wheel](#) on page 44).

Note: Touch the lock icon to unlock/lock all doors. In situations where only the driver's door is unlocked (for example, **Door Unlock Mode** is set to **Driver**), the lock icon displays as unlocked and touching it locks all doors. For more information on **Door Unlock Mode**, see [Doors](#) on page 4.



2. Apps

Touch an app to display it in the viewing area. Apps have default positions. Navigation and Camera open in the top viewing area, whereas all other apps open in the bottom viewing area. Instead of displaying the app in the default viewing area, you can specify where you want to display the app by touching and holding the app's icon and dragging it onto the preferred viewing area.



Media. See [Media and Audio](#) on page 131.



Maps and Navigation (if equipped). See [Maps and Navigation](#) on page 138.

Note: When displaying maps in the top (or entire) viewing area when a driving gear is engaged, the status and app bars at the top disappear after a few seconds to maximize the size of the map. Touch the map to redisplay them.



Calendar. See [Calendar](#) on page 143.



Energy. See [Getting Maximum Range](#) on page 71.



Web. Access the Internet using the web browser (if equipped).



Camera. Display the area behind Model X. This area also displays automatically whenever you shift into Reverse. See [Rear View Camera](#) on page 73.



Phone. See [Phone](#) on page 136.

3. Main viewing area

The main viewing area changes depending on the app you have chosen. For some apps (such as Navigation and Web), you can zoom in and out using standard touchscreen finger gestures.

4. Maximize/minimize app

Touch the small rectangle to expand the associated app to fill the entire main viewing area (some apps are not expandable). Touch again to display two apps in half-screen view.

5. Controls

Touch to access all Model X controls and settings (doors, locks, lights, etc).



6. Climate controls (see [Climate Controls](#) on page 123).
7. Volume control

Touch the up and down arrows to increase or decrease the volume of the speakers. You can also adjust the volume using the scroll wheel on the left side of the steering wheel.

8. Reverse the position of the two currently displayed apps.

 **Warning:** Paying attention to road and traffic conditions must always be the driver's highest priority. To ensure the safety of vehicle occupants as well as other road users, using the touchscreen should be done only when road and traffic conditions permit.



Controlling Features

Touch **Controls** on the bottom corner of the touchscreen to control and customize all main features of Model X.

Note: The following illustration is provided for demonstration purposes only. Depending on vehicle options, software version and market region, the options available on the Controls screen may be different.

The screenshot shows the Tesla Controls interface with the following elements:

- 1**: Close button (X) and Settings button.
- 2**: Doors control.
- 3**: Seats control.
- 4**: Suspension control.
- 5**: Driving control.
- 6**: Cold Weather control.
- 7**: Trips control.
- 8**: **Displays** section header.
- 9**: E-Brake & Power Off control.
- 10**: Ambient lighting controls, including DOME, AMBIENT, DRL, FOG, and HEADLIGHTS (OFF, PARKING, ON, AUTO, AUTO HIGH BEAM).

BRIGHTNESS & MODES

DAY BRIGHTNESS: Auto-adjust [Slider: 100%]

DISPLAY MODES: DAY NIGHT AUTO CLEAN MODE

POWER MANAGEMENT ⓘ

ENERGY SAVING: OFF ON Always connected



1. Close

Touch the circled X in the top left corner of a window to close it (or you can touch anywhere outside the window).

2. Doors

Touch to open or close doors.

3. Seats

If Model X is equipped with monopost second row seats, touch to move the second row seats forward or backward (see [Adjusting Second Row Monopost Seats](#) on page 21).

4. Suspension

If Model X is equipped with Smart Air Suspension, touch to manually raise or lower Model X, or to remove a previously saved auto-raising location (see [Smart Air Suspension](#) on page 129). Model X must be powered on and you must press the brake pedal before you can change suspension settings. Smart Air Suspension causes Model X to self-level, even when powered off. Therefore, when towing or lifting, you must disable self-leveling (see [Instructions for Transporters](#) on page 191 and [Jacking and Lifting](#) on page 172).

5. Driving

- Steering mode

Adjust the amount of effort required to turn the steering wheel. Sport feels more responsive whereas Comfort feels easier to drive and park (see [Steering Wheel](#) on page 44).

- Acceleration (Performance dual-motor vehicles only)

Choose an acceleration level. Sport is the standard level of acceleration and allows you to maximize driving range. Choose Insane to increase peak torque by approximately 30 percent and Ludicrous to increase it by approximately 60%.

If you choose Insane or Ludicrous, additional power is available immediately. However, to achieve the absolute maximum power (designed for short term use), touch **Max Battery Power**, which displays as blue text immediately below the acceleration setting. Max Battery Power heats the Battery to its ideal operating temperature to ensure access to 100% of available power. Heating the Battery can take over an hour, depending on environmental conditions and whether or not Model X is being driven. During this time, a message displays providing you with an approximate wait time. When the additional power is available, the message indicates that Max Battery Power is READY! When using Max Battery Power, Model X consumes more energy as it keeps the Battery within an optimal temperature range. To cancel Max Battery Power at any time, change the acceleration level to Sport (or touch the button in the Max Battery Mode popup). To prevent excess and potentially unnecessary energy consumption (for example, you leave the vehicle and forget to cancel Max Battery Power), Max Battery Power cancels automatically in three hours, regardless of whether you are still driving or have left the vehicle.

Note: To support Max Battery Power, the charge level must be 20% or higher. You cannot initiate Max Battery Power if the charge level is less than 20%. In addition, Max Battery Power immediately cancels if at any time during its use, the charge level drops below 20%.

Note: Max Battery Power strives to keep the pack within an optimal temperature range. In addition to heating the Battery, Max Battery Power also cools the battery when necessary (for example, during aggressive driving scenarios).

Note: Max Battery Power is designed to achieve maximum performance for short term acceleration and is not intended for daily driving. The tradeoff for the additional power boost is extra energy consumption and earlier power fade on long aggressive drives. The Insane or Ludicrous acceleration settings provide a significant increase in performance even without Max Battery Power. In fact, in normal driving situations, the additional power that can be achieved using Max Battery Power may not be noticeable.



- Creep

When on, Model X slowly moves forward when in Drive and backward in Reverse when you release the brake (similar to a conventional vehicle with an automatic transmission). You can adjust this setting only when Model X is in Park.

- Traction Control

In circumstances where you deliberately want the wheels to spin, you can enable Slip Start. A warning message displays on the instrument panel. Although Slip Start disables automatically when driving speed exceeds 50 mph (80 km/h) (or when you start Model X), it is strongly recommended that you disable it immediately after the circumstances that required you to enable it have passed. See [Traction Control](#) on page 64.

- Regenerative braking

When you release the accelerator when driving, regenerative braking slows Model X and feeds any surplus energy back to the Battery. If set to Low, Model X does not slow down as quickly, but you may experience less range (see [Regenerative Braking](#) on page 62).

Note: Regardless of the setting, the energy gained by regenerative braking is reduced if the Battery is full, or if it is extremely cold or hot (the surplus energy is used to heat or cool the Battery).

- Range Mode

If on, Model X conserves energy by limiting the power of the climate control system and turning off signature lighting. Cabin heating and cooling may be less effective, but seat heaters can be used to provide warmth in colder climates. When turned on in a dual-motor vehicle, torque distribution between the motors is optimized to maximize range.

6. Cold Weather

If Model X is equipped with the optional cold weather package, you can control all seat heaters as well as the heated wipers and steering wheel. Heaters that are turned on are displayed in red. To turn off all seat heaters, touch **All Off**. Note that you can also control the front driver and passenger seats using the main climate control panel located on the bottom of the touchscreen (see [Climate Controls](#) on page 123).

7. Trips

View and reset the trip meters that summarize how far you have driven (see [Trip Information](#) on page 70).

8. Displays

Manually control the brightness and the **Day** (light background) or **Night** (dark background) setting of the touchscreen and instrument panel. When set to **Auto**, the brightness changes automatically between day and night brightness based on ambient lighting conditions. When **Auto-adjust** is checked, the displays are further adjusted based on both the surroundings and by learning your preferences (i.e. it remembers the type of manual adjustments you make).

To disable the touchscreen momentarily for cleaning purposes, touch **Clean Mode**.

You can also put Model X into an energy saving mode so it consumes less energy when not in use (see [Getting Maximum Range](#) on page 71).

Note: The Displays settings can also be accessed from the Settings screen.

9. E-Brake & Power Off

You can manually:

- Apply and release the parking brake (see [Parking Brake](#) on page 63).
- Power off (see [Powering Off](#) on page 48).

10. Lights (see [Lights](#) on page 57)

Warning: Do not read the touchscreen while driving. Doing so increases the likelihood of a collision. Everything you need to know when driving is displayed on the instrument panel.



Customizing Your Vehicle

Touch the Settings tab on the Controls window to adjust Model X to suit your preferences.

Note: The following illustration is provided for demonstration purposes only. Depending on vehicle options, software version, and market region, the options available on the Settings screen may be different. For example, in many regions, the “Language & Units” tab is called “Units & Format.”

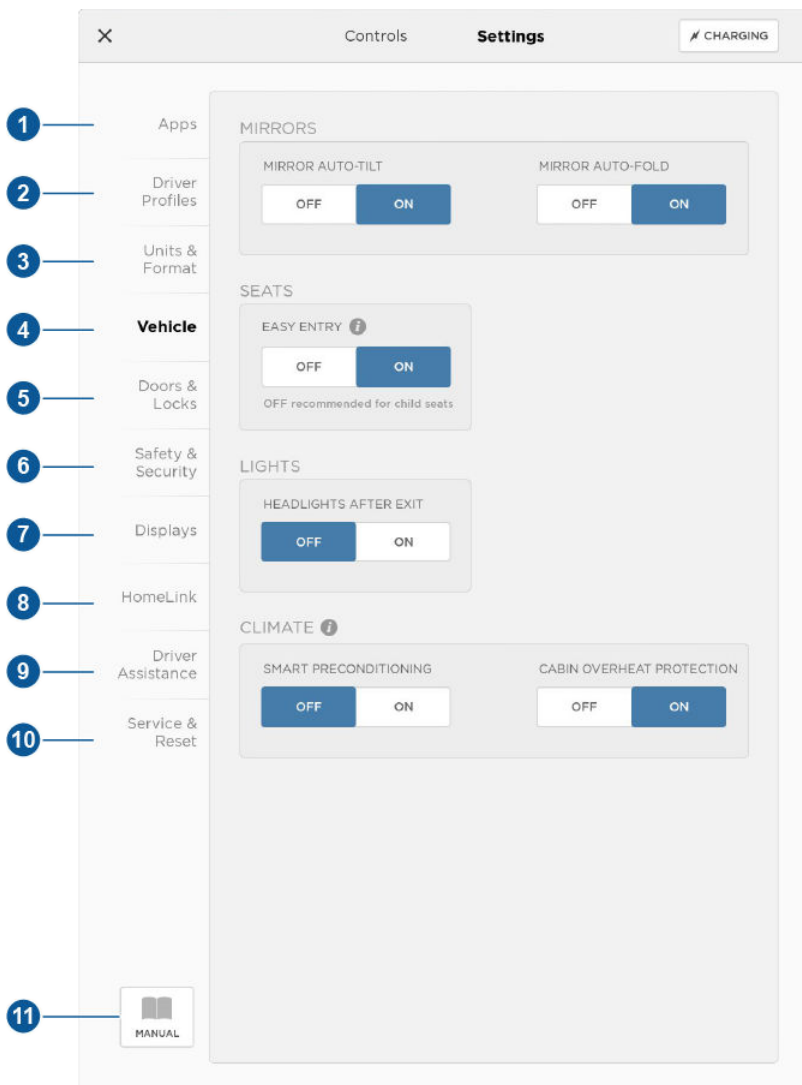



1. Adjust settings associated with installed apps (applications). Settings associated with apps that are either unavailable on Model X, or have no settings that you can adjust at this time, are grayed out.
2. Manage driver profiles (see [Driver Profiles](#) on page 42).
3. Units & Format

Adjust how Model X displays:

- Distance: Miles or km can be shown on the range display, speedometer, energy chart, trip meters, Google map searches and navigation routes.
- Time Format: 12 or 24 hour.
- Temperature: °C or °F.
- Energy & Charging: Display remaining energy and charging units as either a percentage of battery energy remaining, or as an estimate of the distance that you can drive. When you choose Distance, you can display mileage based on either:
 - Rated - based on EPA testing.
 - Ideal - assumes ideal driving conditions based on driving at a steady speed of 55 mph (89 km/h) on a flat road, and using no additional energy (seat heaters, air conditioning, etc).

Note: When anticipating when you need to charge, use range estimates as a general guideline only.

- Tire Pressure: BAR or PSI.

4. Vehicle

Note: Depending on date of manufacture and options chosen at time of purchase, some vehicles are not equipped with all features listed below.

- Easy Entry (vehicles with second row monopost seats only): If on, the associated outside seat and center seat move to provide access to the third row seats (if equipped) with the single press of the Easy Entry button. If off, you must hold the Easy Entry button to move the associated outside seat and center seat. See [Accessing Third Row Seats](#) on page 23.
- Headlights After Exit: If on in low lighting conditions, headlights stay on for one minute after you exit, or until you lock the vehicle (see [Headlights After Exit](#) on page 59).
- Adaptive Headlights (if equipped): If on, the Adaptive Front Lighting System (AFS) automatically adjusts the beam of the headlights to improve your driving view (see [Adaptive Front Lighting System \(AFS\)](#) on page 59).
- Mirror Auto-Tilt: If on, exterior mirrors tilt downward when reversing (see [Mirrors](#) on page 47).
- Mirror Auto-Fold: If on, exterior mirrors fold when you lock Model X with the key, mobile app, or walk-away locking. They extend automatically when you return. You can also fold the mirrors manually by touching the center mirror control button (see [Mirrors](#) on page 47).
- Smart Preconditioning: If on, Model X predicts your driving schedule and automatically adjusts the temperature of the cabin based on your last set temperature and your driving schedule, making Model X comfortable and ready to drive. It may take some time for your vehicle to learn your driving habits and if you do not have a regular driving schedule, it will be unable to identify a pattern. Smart Preconditioning also warms your battery in colder temperatures.

Note: To conserve energy in situations where Model X has a low charge level, smart preconditioning may not occur.

Note: Smart Preconditioning is available only if you save your home and work locations (see [Favorite, Home, and Work Destinations](#) on page 141).



- Cabin Overheat Protection: If on, the air conditioning system can reduce cabin temperatures in extremely hot ambient conditions for a period of up to twelve hours after exiting Model X (see [Cabin Overheat Protection](#) on page 128).

⚠ Warning: Never leave children or pets in the vehicle unattended. Due to automatic shut-off or extreme outside conditions, the inside of the vehicle can become dangerously hot even with Cabin Overheat Protection enabled.

Note: Cabin Overheat Protection does not operate when the energy remaining in the Battery is 20% or less.

- Autowipers (Beta): If on, wipers turn on automatically when Model X detects rain on the windshield. You must also set the wipers to an Auto setting (see [Wipers and Washers](#) on page 61).

5. Doors & Locks

Note: Depending on date of manufacture and options chosen at time of purchase, some vehicles are not equipped with all features listed below.

- Door Unlock Mode: Choose whether you want **ALL** doors, or just the **DRIVER** door, to unlock when you approach Model X carrying your key.
- Child-Protection Lock: If on, safety locks prevent the rear doors and the liftgate from being opened from inside the vehicle.
- Walk-away Door Lock: If on, doors automatically lock when you walk away from the vehicle, carrying your key with you (see [Walk-away Locking](#) on page 10).
- Automatic Doors: With Automatic Doors set to **ON**, the door (or doors, if Door Unlock Mode is set to **ALL**) unlocks and the driver's door opens whenever you approach Model X. If off, the door/doors unlock, but the driver's door doesn't open. Also, if on, the passenger door opens if you double-click the key's lock/unlock button after the driver's door has opened (see [Opening and Closing Front Doors from Outside Model X](#) on page 7).
- Unlock on Park: If on, doors automatically unlock when you engage the Park gear.
- Falcon Door Height: If set to **AUTO**, the falcon wing doors will open fully (respecting any remembered location-based heights and assuming no obstacle is detected). If set to **LOW**, the falcon wing doors will open partially, further protecting the vehicle's interior and occupants from inclement weather.
- Close All With Key Fob: If on, all doors (and the rear trunk) close and lock when you single-click the key's lock/unlock button (if set to **OFF**, you must triple-click this button).
- Passive Entry: If on, doors automatically unlock whenever you approach Model X carrying a key. If off, you must use the key to unlock Model X. See [Using the Key](#) on page 4.

Note: You must press the brake pedal to power Model X on before you can change the Passive Entry setting. See [Starting](#) on page 48.

Note: If Passive Entry is off and you do not press the brake pedal to start Model X within approximately five minutes, a message displays on the instrument panel and you must use the key to lock then unlock Model X again before starting the vehicle.

6. Safety & Security

Turn various safety, security, and privacy features on and off:

- Active safety devices Model X is equipped with, such as Park Assist Chimes (see [Park Assist](#) on page 65).
- Security features that Model X is equipped with, such as the alarm (see [Security Settings](#) on page 144).
- Privacy features such as allowing access by Tesla's mobile applications (see [Mobile App](#) on page 149) and enabling the sharing of road measurement data (see [Data Sharing](#) on page 196).

7. Displays

Manually control the brightness and the **DAY** (light background) or **NIGHT** (dark background) setting of the touchscreen and instrument panel. When set to **AUTO**, the brightness changes automatically between day and night brightness based on ambient lighting conditions. When **Auto-adjust** is checked, the displays are further adjusted based on both the surroundings and by learning your preferences (i.e. it remembers the type of manual adjustments you make).

To disable the touchscreen momentarily for cleaning purposes, touch **CLEAN MODE**.

You can also put Model X into an energy saving mode so it consumes less energy when not in use (see [Getting Maximum Range](#) on page 71).

Note: The Displays settings can also be accessed from the Controls screen.

8. HomeLink (if equipped)

If the HomeLink feature is available in your region, use it to control RF-enabled garage doors, lights, or security systems (see [HomeLink Universal Transceiver](#) on page 145).

9. Driver Assistance

If Model X is equipped with Driver Assistance components, you can control the features that provide a safer and more convenient driving experience (see [About Driver Assistance](#) on page 84).

10. Service & Reset

Turn various service-related features on and off:

- **Service Mode:** If on, moves wiper blades to the service position to make them easier to access when replacing them. Your Model X must be in Park (see [Wipers and Washers](#) on page 61).
- **Tow Mode:** Activate Tow Mode to keep Model X in Neutral (see [Keeping Your Vehicle in Neutral \(Tow Mode\)](#) on page 50).
- **Factory Reset:** Touch **ERASE & RESET** to erase all personal data (saved addresses, music favorites, etc.) and restore all customized settings to their factory defaults.

11. Manual

Display this owner's manual.

Note: If upgrades are available for Model X (for example, an upgrade to include Autopilot or to increase driving range), the **Upgrades** tab also appears on the Settings window. Simply choose the upgrade that you want to purchase, then follow the onscreen instructions.

Warning: Do not read the touchscreen while driving. Doing so increases the likelihood of a collision.

Naming Your Vehicle

To further personalize Model X, you can name it. The name you give your Model X will appear in the mobile app. To name your vehicle, touch the **Tesla "T"** at the top center of the touchscreen, then touch **Name Your Vehicle**.

When you save, **Name Your Vehicle** is replaced by the name you provided. You can touch the name at any time to rename your vehicle.

Erasing Personal Data

You can erase all personal data (saved addresses, music favorites, imported contacts, HomeLink programming, etc.) and restore all customized settings to their factory defaults. This is useful when transferring ownership of Model X. Touch **Controls > Settings > Service & Reset > FACTORY RESET > ERASE & RESET**. Before erasing, Model X verifies your credentials by prompting you to enter the user name and password associated with your Tesla Account.



Overview of Climate Controls

The climate controls are always available at the bottom of the touchscreen. By default, climate control is set to Auto, which maintains optimum comfort in all but the most severe weather conditions. When you adjust the temperature, the system automatically adjusts the heating, air conditioning, air distribution, air circulation, and fan speed to maintain your selected temperature. To override these settings, touch **Auto** (see [Customizing Climate Control](#) on page 124).

The fan, heating, and air conditioning systems are powered by the Battery. Therefore, prolonged use decreases driving range.

Note: The following illustration is provided for demonstration purposes only. Depending on vehicle options, software version, market region, and settings, the information displayed may be slightly different.

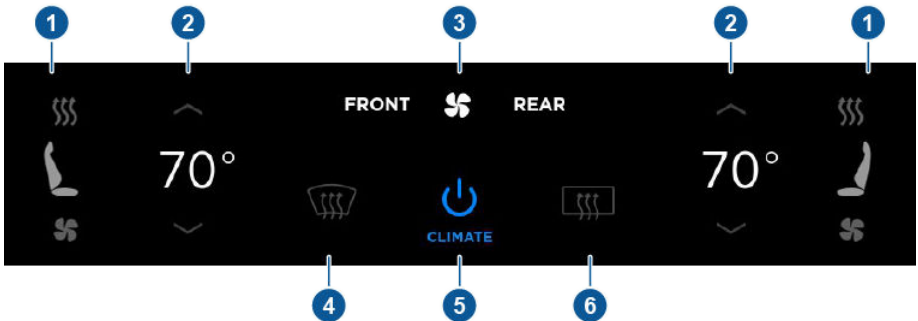

1. The front seats are equipped with heating/cooling pads. When operating, the top indicator turns red when heating or the bottom indicator turns blue when cooling.

Note: If Model X is equipped with the optional cold weather package, you can also control seat heaters in the rear seats, heated wipers, and heated steering wheel by touching **Controls > Cold Weather** (see [Controls](#) on page 116).

2. Touch the up or down arrow to set the cabin temperature. To apply a temperature setting to both the driver and passenger side at the same time, touch **SYNC TEMP** on the temperature popup that appears when you touch an arrow.
3. Touch the fan icon to customize and automate climate control settings for the front and rear cabin. (See [Customizing Climate Control](#) on page 124.)

Note: Rear climate controls are available only if Model X is equipped with six or seven seating positions.

4. The windshield defroster distributes air flow to the windshield. Touch once to turn on, touch a second time to operate the heating and fan at their maximum level, and touch a third time to turn off and restore the air distribution, heating, and fan to their previous settings.
5. Turn climate control system on/off.

Note: The label on this button says Keep Climate On if you have set the climate control system to maintain your temperature settings when parked (see [Customizing Climate Control](#) on page 124).

6. The rear window defroster warms up the rear window for 15 minutes, then automatically shuts off. Exterior side mirrors are also heated.

⚠ Warning: To avoid burns resulting from prolonged use, individuals who have peripheral neuropathy, or whose capacity to feel pain is limited because of diabetes, age, neurological injury, or some other condition, should exercise caution when using the climate control system and seat heaters.



Customizing Climate Control

The climate control system is designed to automatically provide optimum comfort in most situations. All you need to do is set the desired temperature, and the air conditioning, air recirculation, air distribution, and fan speed automatically maintain your selected temperature. You can even keep the climate control system on while you are away from the vehicle so that the selected temperature is maintained.

To override the automatic setting, touch **FRONT** or **REAR** to customize individual settings for the front or rear seating areas. Then touch the setting you want to change. Touch **RESET AUTO** to change all settings on the panel back to their defaults. Or, you can touch **AUTO** associated with any individual setting to change it back to its default.

Note: Rear climate controls are available only if Model X is equipped with six or seven seating positions.

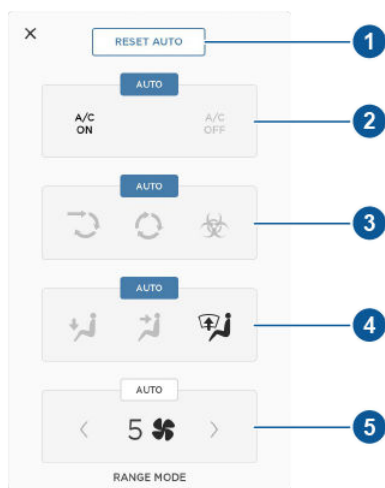

In addition to the five settings shown above (and described below), if Model X is in Park, a Climate Timer displays below the above popup (see [Keep Climate On](#) on page 127).

1. Touch **RESET AUTO** to change all settings on the currently displayed customization panel back to their default values.
2. Touch **A/C ON** or **A/C OFF** to turn the air conditioning on and off, respectively. Turning it off reduces cooling, but saves energy.

Because Model X runs much quieter than a gasoline-powered vehicle, you may notice the sound of the A/C compressor as it is operating. To minimize noise, reduce the fan speed.



3. Choose how air is drawn into Model X:



Outside air is drawn into Model X (see [Ventilation](#) on page 128).



Air inside Model X is recirculated. This prevents outside air (traffic fumes) from entering, but reduces dehumidifying performance. Recirculating the air is the most efficient way to cool the front cabin area. To prevent the windshield from fogging in some conditions, briefly change the setting every hour to draw in outside air.



If your Model X is equipped with the HEPA (High Efficiency Particulate Air) filter, you can ensure the best possible quality of air inside the cabin. When selected, outside air is drawn in and filtered through the medical-grade HEPA filter in addition to the secondary filtration systems. The HEPA filter is extremely effective at removing particles, including pollution, allergens, bacteria, pollen, mold spores, and viruses. Both the HEPA filter and the secondary filtration system also contain activated carbon to remove a broad spectrum of odors and gases. When you engage the HEPA option, the fan operates at the highest speed. In addition, the positive pressure inside the cabin minimizes the amount of outside air that can leak into the vehicle.

Note: Some gases, such as carbon monoxide, are not effectively removed by activated carbon.

4. Choose where air flows into the cabin. You can choose more than one location:



Foot-level vents



Face-level vents



Windshield vents

Note: When air is directed to the foot-level vents, approximately one third of the air continues to flow to the windshield vents to assist in defogging. However, when air is directed to the face-level vents, no air flows to the windshield because the air flowing through the face-level vents may be adequate to assist in defogging the windshield.

5. Touch the arrows to set the speed of the fan.

Note: Adjusting the fan speed may change the selected setting for how air is drawn into Model X in order to increase or reduce airflow. If you set the fan speed very high (for example, setting 10), Model X may automatically switch from drawing in outside air to recirculating air to achieve the high air flow. Touch **RESET AUTO** to reset all settings to their default values.



Rear Cabin Climate Controls (6 and 7 seat vehicles only)

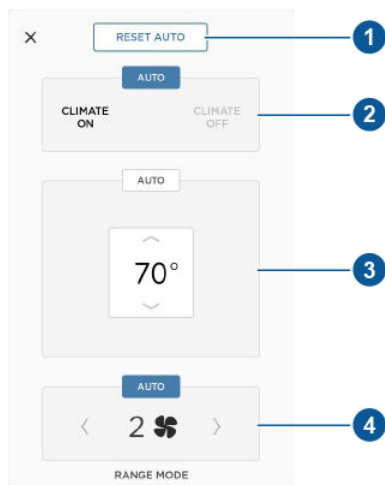

Note: When set to **AUTO**, the rear heating and air conditioning turn off when Model X detects that there are no occupants in the second or third row seats. To override this energy saving feature and save the settings until you manually change them, touch the **AUTO** button located above the **Climate On/Climate Off** setting. Touching **AUTO** a second time cancels your manual setting and resumes the energy saving feature.

1. Touch **RESET AUTO** to change all settings back to their default values.
2. Touch **CLIMATE ON** or **CLIMATE OFF** to turn the air conditioning on and off, respectively. Turning it off reduces cooling, but saves energy.

Note: Because Model X runs much quieter than a gasoline-powered vehicle, you may notice the sound of the A/C compressor as it is operating. To minimize noise, reduce the fan speed or recirculate the air.

3. Touch the arrows to adjust the temperature.
4. Touch the arrows to set the speed of the fan.



Keep Climate On

The Keep Climate On settings allows you to keep your climate control system running as long as the vehicle is in Park, even after you've left. This is useful in situations where it is important that the cabin is maintained at a comfortable temperature (for example, you are leaving your pet in Model X or you are sleeping in Model X). To use the Keep Climate On setting, the Battery's charge level must be at least twenty percent.

To operate Keep Climate On:

1. Engage the Park gear. The Keep Climate On setting is available only when Model X is in Park.
2. On the Climate Controls, touch **FRONT**. The Climate Timer appears below the individual settings you use to adjust the climate settings in the front seating area.
3. If necessary, adjust the climate settings.
4. Touch **Keep Climate On > ON**.

The climate control system maintains your climate settings until you shift out of Park or manually turn it off. If the Battery's charge level drops to twenty percent, the climate control system automatically turns off and the Tesla mobile app sends you a notification reminding you to check on anything that you have left in Model X.

The next time you start Model X, the climate control system will continue operating using the previous settings from your most recent drive.

 **Warning:** Never depend on the climate control system to continue operating. Doing so can cause serious injury and/or death (for example, leaving a dog in the car on a hot day).



Ventilation

To direct the flow of air inside Model X, move the interior vents up, down, or from side to side.

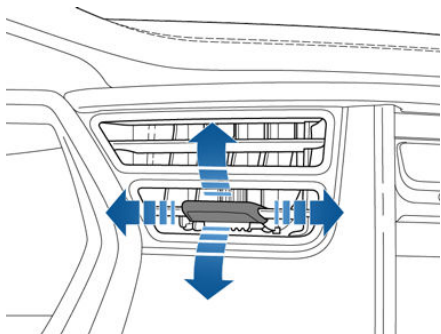

Note: You can direct the outer face level vents toward the side windows to help defrost or defog them.

Cabin Air Filter

Model X has an air filter that prevents pollen, industrial fallout, road dust and other particles from entering through the vents. Tesla replaces the air filter at the regularly scheduled maintenance intervals of every 12 months, or every 12,500 miles (20,000 km).

Cabin Overheat Protection

The climate control system can reduce cabin temperatures in extremely hot ambient conditions for a period of up to twelve hours after you exit Model X. When enabled, air conditioning turns on when cabin temperatures exceed 105° F (40° C). To disable this feature, touch **Controls > Settings > Vehicle > Cabin Overheat Protection > OFF**.

Warning: Never leave children or pets in the vehicle unattended. Due to automatic shut-off or extreme outside conditions, the inside of the vehicle can become dangerously hot even with Cabin Overheat Protection enabled.

Note: Cabin Overheat Protection does not operate, or stops operating, when the energy remaining in the Battery is 20% or less.

Climate Control Operating Tips

- When you use the mobile app to turn on the climate control system, it automatically turns off after 30 minutes. To cool or heat the cabin for a longer period, you must turn it on again.
- To conserve energy, you can limit the power of the climate control system by turning on Range Mode. Cabin heating and cooling may be less effective, but seat heaters can be used to provide warmth in colder climates. Touch **Controls > Driving > Range Mode**.
- If the climate control system operates more loudly than you prefer, reduce the fan speed.
- In addition to cooling the interior, the A/C compressor also cools the Battery. Therefore, in hot weather, the A/C compressor can turn on even if you turned it off. This is normal because the system's priority is to cool the Battery to ensure it stays within an optimum temperature range to support long life and optimum performance.
- To ensure the climate control system operates efficiently, close all windows and ensure that the exterior grill in front of the windshield is free of ice, snow, leaves, and other debris.
- In very humid conditions, it is normal for the windshield to fog slightly when you first turn on the air conditioning.
- It is normal for a small pool of water to form under Model X when parked. Extra water produced by the dehumidifying process is drained underneath.
- To reduce the temperature in the cabin in hot weather conditions, the fan may turn on to vent the cabin when the vehicle is parked. (This occurs only if the battery's charge level is above 20%.)



Note: If Model X is equipped with Smart Air Suspension, you may hear the sound of the compressor when Model X starts, as the system's reservoir fills with air.

Smart Air Suspension has both manual and automatic modes of operation.

Height Adjustments

⚠ Caution: Before adjusting the suspension height, ensure Model X is clear of all obstacles, above and below.

Manually raising the height of Model X is useful when you need extra ground clearance, such as steep driveways or ramps, deep snow, speed bumps, parking curbs, etc.

With Model X powered on, or the brake pedal pressed, use the touchscreen to manually change the ride height. Touch **Controls** > **Suspension**, then choose from:

- **Very High.** When set to Very High, the suspension automatically lowers to High when driving speed reaches 35 mph (56 km/h).
- **High.** When set to High, the suspension automatically lowers to Standard when driving speed reaches 45 mph (73 km/h).
- **Standard.** The Standard setting ensures optimum comfort and handling under all loading conditions.
- **Low.** Lowering the height can make it easier to load or unload cargo and passengers.
- **Very Low.** This setting is performed manually and applies to the current drive only.

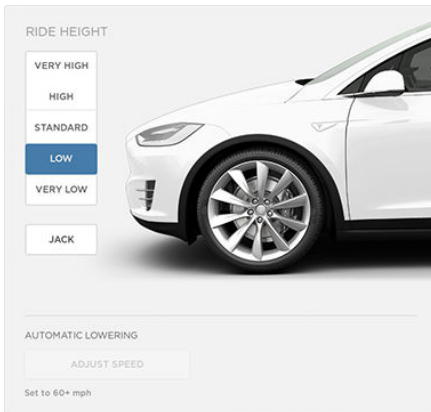

Note: Available settings depend on your driving speed and other conditions. For example, the suspension does not lower if a door is open.

Location-Based Suspension

Location-Based suspension saves you from manually having to raise the suspension every time you arrive at a frequently-used location where a higher suspension is needed (steep driveways or ramps, deep snow, speed bumps, etc.).

Whenever you raise the suspension to **High** or **Very High**, Model X saves the location.

When you return to the saved location, Model X raises the suspension and the instrument panel displays this message:



Note:

- When you are returning to a saved location and driving faster than the High and Very High suspension settings allow (see [Height Adjustments](#) on page 129), the suspension does not raise until Model X slows down.
- After leaving a saved location, the suspension may not lower based on an automatic lowering speed that you have set (**Controls** > **Suspension** > **Automatic Lowering**) until you are driving faster than the speed thresholds.
- If Model X reaches a saved location and the existing suspension setting is higher than the level that has been saved for that location, the suspension is not adjusted.

To remove an auto-raising location

If you do not want the suspension to auto-raise at a saved location, touch the **X** in the auto-raising location status message that displays at a saved location. Doing so removes the auto-raise location and the suspension no longer raises automatically when you arrive at the location.

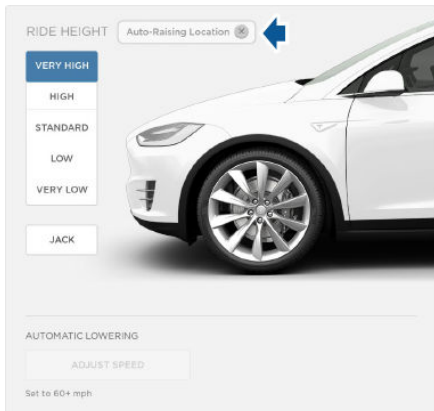

Note: Manually lowering the suspension to **Standard** or **Low** while at a saved location also removes the auto-raising location.

Automatic Lowering

When Model X is moving above typical driveway or parking lot speeds, Smart Air Suspension automatically lowers ride height to improve aerodynamics and handling. For most average speed driving, the suspension is automatically set to Standard. As described above, when you make manual height adjustments, the suspension automatically lowers at increased driving speeds.

When carrying loads, Smart Air Suspension also maintains a level height between the front and rear.

You can adjust the speed at which the Air Suspension automatically transitions to the **LOW** ride height by touching **Controls > Suspension > Automatic Lowering** on the touchscreen. This setting is saved to your **Driver Profile**.

Note: You can temporarily override the ride height by pressing the brake pedal, touching an air suspension control in **Controls > Suspension**, and then manually choosing a ride height. Your suspension's automatic lowering setting is restored the next time you drive.



If a fault is detected that reduces the performance of the air suspension system, a yellow indicator lights up on the instrument panel. If the problem persists, contact Tesla.

Jack Mode

Before jacking or lifting, set the suspension to **Jack** mode to prevent the self-leveling that occurs even when Model X is powered off.

Press the brake pedal, then touch **Controls > Suspension > Jack**.

To deactivate, touch **Jack** again.

Note: **Jack** mode automatically cancels when you drive over 4 mph (7 km/h).

Note: Model X also sets Jack mode automatically if it detects that the vehicle cannot lower to its target height, or if it detects that an object is supporting the vehicle's weight (for example the bumper of the vehicle is resting on a curb).



Overview

Touch the **Media Player** application to listen to Internet radio, stream music or podcasts (if available), or play audio files from a Bluetooth or USB-connected device. You can play FM, and SiriusXM satellite (if equipped) radio.

Available source content displays across the top of Media Player: Radio, Streaming, Tuneln, and Phone. An additional source, USB, displays when you insert a flash drive into a USB connection (see [USB Connections](#) on page 134). You can browse the content available on Media Player by touching a source, or you can use Search to find specific content (see [Searching within Media Player](#) on page 131).

The Now Playing view, which displays at the bottom of Media Player, enables you to control what's currently playing (for example, pausing/playing, skipping to the next track/station, etc.). You can also use the Now Playing view to mark what's playing as a favorite (see [Favorites and Recent](#) on page 133), and access recently played and favorite stations, music, and podcasts.

The Now Playing view displays regardless of the source (Radio, Streaming, Tuneln, Phone, and USB) you select in Media Player. You can maximize and minimize the Now Playing view simply by touching it.

Volume Control

To adjust Media Player's volume, roll the scroll wheel on the left side of the steering wheel up or down. To mute the volume, press the left scroll wheel.

The scroll wheel adjusts the volume for media, navigation instructions, or phone calls, based on what is currently being heard through the speakers. If you're listening to a song, audio file, or podcast, and you receive a phone call or Model X relays a step in Trip Planner's turn-by-turn directions through the speakers, the song, audio file, or podcast is muted temporarily.

Note: Pressing the left scroll wheel during a phone call mutes both the sound and your microphone.

Audio Settings

Achieve the sound you want by adjusting the fade (front/rear) and balance (left/right), or by customizing the strength of sound frequencies. Press the equalizer icon on the top right corner of the Media Player to access audio settings.

Adjust fade and balance on the left side of the screen by positioning the center circle of the cross bars to the location in Model X where you want to focus the sound. Adjust any of the five frequency bands (Bass, Bass/Mid, Mid, Mid/Treble, and Treble) on the right side of the screen by dragging the corresponding slider up or down on the decibel (dB) bar.

If equipped, touch the **Dolby** check box to enable Dolby Surround.

Searching within Media Player

Search is available throughout Media Player. You can search across all content categories, or you can limit your search to a particular category. Search results include the following content:

- Tuneln
- Streaming Personal Radio
- USB content

To search, touch anywhere in Media Player's search bar and enter the name of the song, album, artist, podcast, playlist, or station you want to search for. Select a filter to narrow the scope of your search, or leave it at its default setting to include top results from all categories.

Note: You can also search hands-free using voice commands (see [Using Voice Commands](#) on page 46).

If you are using Tuneln, you can browse content by category from the Browse area of the Tuneln source. You can browse content by location (Africa, Asia, North America, and so on), by local radio, by talk radio, by favorites, and other categories. To return from browsing or to select another category to browse, simply touch Tuneln at the top of Media Player.



FM Radio

If it's available in your location, Media Player provides FM radio service that you can select from the Radio source. To tune the radio to a specific frequency, choose a frequency and then touch the next or previous arrows to move from one frequency to the next (or previous). You can also tap or drag your finger on the tuner to the desired frequency. The three bars on the left side of the frequency number indicate the strength of the signal for the chosen frequency. Touch HD to play high definition versions of available frequencies.

Mark a radio station as a favorite to display it on the Radio source for easy access (see [Favorites and Recent](#) on page 133).

SiriusXM Satellite Radio

If Model X is equipped with the optional sound package, you can listen to SiriusXM, a subscription-based satellite radio service. To receive satellite radio channels, you must provide the radio service provider with the radio ID for your touchscreen.

To display the radio ID:

1. Touch **Radio** and select the SiriusXM radio source.
2. Move the channel selector to channel 0.
3. The Radio ID displays in the station information area.

To select a SiriusXM channel, you can either manually scroll through channel numbers, or you can browse channels by category.

Note: SiriusXM radio is available only if Model X is equipped with the optional sound package. To optimize aerodynamics, Model X does not have an external antenna.

Internet Radio

Internet radio services are accessed over a data connection. To use Internet radio, touch Media Player's **Streaming** or **TuneIn** source, browse through the available categories and/or stations, and then touch what you want to play. When browsing through a large category such as genres, a second browse page displays. Use the left arrow button on the left side of Media Player to return to the prior page, or tap on the source again to return to the main browse page.

With your Personal Streaming Radio account, you can create a radio station of your favorite songs and songs that are similar to your favorites. When you like a song by touching **thumbs up**, it is added to your Favorites and is used to tune your listening profile so that similar songs are also added to your Favorites station. If you dislike a song by touching **thumbs down**, the song is removed from your Favorites station.

Note: Your Favorites station is linked to your Personal Streaming Radio account for the car.

To play the next (and in some cases previous) available station, episode, or track being provided by the Internet radio service, touch the next (or previous) arrows on the Now Playing view, or use the buttons on the left side of the steering wheel (see [Using Left Steering Wheel Buttons](#) on page 44). The function of these controls vary depending on the Internet service you are listening to.

You can also use voice commands only available when speaking the English language only) to play a specific song, artist, or album from an Internet radio service (see [Using Voice Commands](#) on page 46).

When you are listening to internet radio, you can do the following on the Now Playing view:

- Touch the **thumbs up** or **thumbs down** icon (if available) to like or dislike any song or podcast. When you like a song, more songs like that song will be played. When you dislike a song, the song won't be played again.
- Touch the **DJ** icon (if available) to include commentary for the content you are streaming. DJ commentary includes music history and behind-the-scenes stories.
- Touch the **Favorites** icon to save the radio station or podcast as a favorite (see [Favorites and Recent](#) on page 133).



- Touch any number to access digital radio stations (if available). Digital radio stations provide higher quality sound and, in some cases, different programming than their analog equivalents.
- Touch the **right arrow** to view a list of tracks for a podcast or playlist.

By default, Tuneln uses a Tesla account that has been set up for you. To sign in to a different Tuneln account, scroll to the bottom of the **Tuneln** source, touch **Sign In**, and enter the login information for the account.

Note: When playing a Tuneln podcast, you can rewind or fast forward to any location in the podcast. On the Now Playing view, drag the arrow below the slider bar to the desired location.

Note: Tesla also provides you with a complimentary Streaming Personal Radio account for four years. To use your own Slacker Plus or Premium account instead, scroll to the bottom of the **Streaming** source, enter your credentials, touch **Use High Bitrate** to stream higher quality sound (if your Model X is equipped with the optional Ultra High Fidelity Sound package), and then touch **LOGIN**. To switch back to your Tesla account, simply touch **USE TESLA ACCOUNT**; you don't need to enter a user name or password for your Tesla account. You can purchase your own Slacker Plus or Premium account at www.slacker.com. Model X does not support basic (free) Slacker services.

Favorites and Recent

To ensure you always have easy access to your favorite stations and audio files, they display at the top of Media Player and on the Now Playing view. Regardless of which source you are on (Radio, Streaming, Tuneln, Phone, or USB), you see favorites from all sources. You can maximize or minimize source content simply by swiping.

Your USB favorites are available from the Now Playing view in a Favorites folder. (You may need to scroll to see the folder.) Your first USB favorite plays when you touch the **Favorites** folder in the Now Playing view. Use the next or previous arrows to scroll through your USB favorites.



To add a currently playing radio station, podcast, or audio file to your Favorites list, touch the **Favorites** icon on the Now Playing view. (You may need to touch the Now Playing view to maximize it before you can touch the Favorites icon.)



To delete a favorite, touch the highlighted **Favorites** icon. You can also delete one or more favorites on the bottom of the Now Playing view by pressing and holding a favorite. An **X** appears on all favorites. Touch the **X** again to delete the selected favorites.

To see selections that you played recently, touch **Recent** on the Now Playing view. Your recently played selections are updated continuously so you don't need to delete them.

Note: Selections you play on FM radio stations do not display in your Recent selections.

Playing Media from Devices

You can play audio files from a USB-connected flash drive or from a Bluetooth-connected device (like a phone). When you connect a USB flash drive, Media Player displays the USB source content. When you connect a Bluetooth-capable device, the name of the device displays on the Phone source. After connecting a USB flash drive or Bluetooth device, touch the song, album, or playlist you want to play.

To play the next song in a selected playlist or album, touch the previous or next arrows on the Now Playing view, or use the buttons on the left side of the steering wheel (see [Using Left Steering Wheel Buttons](#) on page 44). You can also shuffle tracks in a playlist or repeat a playlist or track using the shuffle/repeat icons displayed below the album cover art.



USB Connected Flash Drives

Connect a flash drive to one of the USB connections (see [USB Connections](#) on page 134). Touch **Media Player** > **USB**, and then touch the name of the folder that contains the song you want to play. After you display the contents of any folder on the USB connected flash drive, you can touch the right arrow in the Now Playing view to display your songs in a list. Touch any song in the list to play it. Or use the previous and next arrows in the Now Playing view to scroll through your songs.

Note: To play media from a USB connection, Model X recognizes flash drives only. You can play media from other types of devices (such as an iPod) by connecting to the device using Bluetooth (described below).

Note: Use a USB connection located at the front of the center console (see [USB Connections](#) on page 134). The USB connections at the rear of the console are for charging only.

Note: Media Player supports USB flash drives with FAT32 formatting. (NTFS and exFAT are not currently supported.)

Bluetooth[®] Connected Devices

If you have a Bluetooth-capable device such as a phone that is paired and connected to Model X (see [Pairing a Bluetooth Phone](#) on page 136), you can play audio files stored on it. You can also stream a music service from it (for example, Pandora or Spotify). Choose Media Player's **Phone** source, touch **Connect Phone**, touch the name of your Bluetooth-connected device, and then touch **CONNECT**.

Your Bluetooth device begins playing the audio file that is currently active on your device, and Media Player displays the Now Playing view. If an audio file is not playing on your device, select the audio file you want to listen to from your device. After an audio file begins to play in Media Player, you can then use Media Player's controls to play other tracks.

Note: To play media from a Bluetooth-connected device, ensure that access to the device's media is turned on (see [Phone](#) on page 136).

USB Connections

Your Model X has two USB connections located on the front of the center console that you can use to connect USB devices. To play audio files stored on a USB drive connected to these ports, see [Playing Media from Devices](#) on page 133. You can also use these connections to charge USB devices.

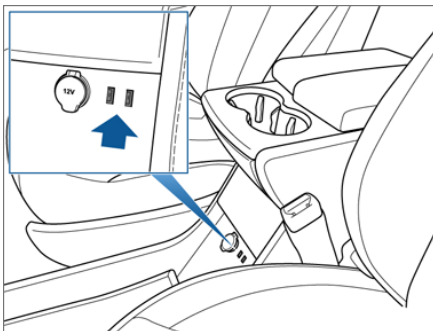

In addition, Model X has two charge-only USB connections located at the rear of the center console, and another charge-only connection located between the third row seats.

Note: You can charge four devices simultaneously using the two ports at the front of the center console and the two at the rear of the console.

12V Power Socket

Your Model X has a power socket located on the front of the center console. An additional 12V power socket is located in the rear trunk. Power is available whenever the instrument panel and touchscreen are on.

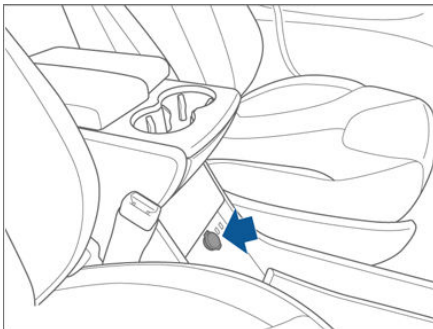



The 12V power sockets are suitable for accessories requiring up to 11A continuous draw (15A peak) or a maximum of 150 continuous watts (180 watts peak).

Note: In situations where Model X is unable to detect the key (low battery, interference, etc.), place it immediately below the 12V power socket in the center console where Model X can best detect it.

 **Warning:** The power socket and an accessory's connector can become hot.



Bluetooth® Compatibility

You can use your Bluetooth-capable phone hands-free in Model X provided your phone is within operating range. Although Bluetooth typically supports wireless communication over distances of up to approximately 30 feet (9 meters), performance can vary based on the phone you are using.

Before using your phone with Model X, you must pair it. Pairing sets up Model X to work with your Bluetooth-capable phone (see [Pairing a Bluetooth Phone](#) on page 136).

You can pair up to ten Bluetooth phones. Model X always automatically connects to the last phone that was used (provided it is within range). If you want to connect to a different phone, see [Connecting to a Paired Phone](#) on page 137.

Note: On many phones, Bluetooth turns off if the phone's battery is low.

Note: In addition to phones, you can also pair Bluetooth-enabled devices with Model X. For example, you can pair an iPod Touch or an iPad or Android tablet to stream music.

Pairing a Bluetooth Phone

Pairing sets up Model X to work with your Bluetooth-capable phone. Once a phone is paired, Model X can connect to it whenever the phone is within range.

To pair a phone, follow these steps while sitting inside Model X:

1. Ensure both the touchscreen and the phone are powered on.
2. On the touchscreen's status bar, touch the Bluetooth icon.
3. On your phone, enable Bluetooth and set it to discoverable.
4. On the Model X touchscreen, touch Start Search. The touchscreen searches then displays the list of all available Bluetooth devices within operating distance.
5. On the Model X touchscreen, touch the phone with which you want to pair. Within a few seconds, the touchscreen displays a randomly generated number, and your phone should display the same number.
6. Check that the number displayed on your phone matches the number displayed on the touchscreen. Then, on your phone, confirm that you want to pair.

When paired, Model X automatically connects to the phone, and the touchscreen displays the Bluetooth symbol next to the phone's name to show that the connection is active.

Importing Contacts and Recent Calls

Once paired, you can use the Bluetooth settings screen (touch the Bluetooth icon on the touchscreen's status bar) to specify whether you want to allow access to your phone's contacts and recent calls.

If access is turned on, you can see your list of contacts and recent calls on the Model X touchscreen. **Touch Phone > Contacts.** You can then touch a contact to dial its phone number or navigate to its address.

Note: Before contacts can be imported, you may need to either set your phone to allow syncing, or respond to a popup on your phone to confirm that you want to sync contacts. This varies depending on the type of phone you are using. For details, refer to the owner documentation provided with your phone.

If access is turned on, imported information is displayed when you touch the contacts tab on the Phone app.

Note: For security reasons, erase your contacts if you sell Model X (see [Erasing Personal Data](#) on page 122).

Unpairing a Bluetooth Phone

If you want to disconnect your phone and use it again later, simply touch **Disconnect** on the Bluetooth settings screen. If you do not want to use your phone with Model X again, touch Forget This Device. Once you forget a device, you need to pair it again if you want to use it with Model X (see [Pairing a Bluetooth Phone](#) on page 136).

Note: Your phone automatically disconnects whenever you leave Model X.



Connecting to a Paired Phone

Model X automatically connects with the last phone to which it was connected, provided it is within operating range and has Bluetooth turned on. If the last phone is not within range, it attempts to connect with the next phone that it has been paired with.

To connect to a different phone, touch the Bluetooth icon on the touchscreen's status bar. The Bluetooth window displays a list of paired phones. Choose the phone you want to connect to, then touch **Connect**. If the phone you want to connect to is not listed, follow the instructions on [Pairing a Bluetooth Phone](#) on page 136.

When connected, the Model X touchscreen displays the Bluetooth symbol next to the phone name to show that the connection is active.

Making a Phone Call

You can make a phone call by:

- Speaking a voice command (English) (see [Using Voice Commands](#) on page 46).
- Choosing a contact from your contact list.
- Using the Model X on-screen dialer.

To make a phone call using the on-screen dialer:

1. Touch the Phone app on the touchscreen, then touch Dialer.
2. Enter the phone number on the dialer.
3. Touch **Call**. The touchscreen displays the call screen and the number you are calling.

To make a phone call by choosing a contact:

1. Touch the Phone app on the touchscreen, then touch **Contacts**.
Note: Ensure that access to the phone's contacts is turned on (see [Importing Contacts and Recent Calls](#) on page 136).
2. Touch the name of the contact you want to call to display details about the contact.
3. Touch the number you want to dial (if you have more than one number for the contact). The touchscreen displays the call screen and the name of the contact you are calling.

Note: If it is safe and legal to do so, you can also initiate a call by dialing the number or selecting the contact directly from your phone.

Receiving a Phone Call

When your phone receives an incoming call, both the instrument panel and the touchscreen display the caller's number or name (if the caller is in your phone's contact list and Model X has access to your contacts).

Touch one of the options on the touchscreen, or use the scroll wheel on the right side of the steering wheel to **Answer** or **Ignore** the call (see [Using Right Steering Wheel Buttons](#) on page 45).

In Call Options

When a call is in progress, you can display the call menu on the instrument panel by pressing the top button on the right side of the steering wheel. Then use the right scroll wheel to scroll through and choose an option (see [Using Right Steering Wheel Buttons](#) on page 45). To adjust the call volume, roll the steering wheel's left scroll wheel during a call.

Warning: Stay focused on the road at all times while driving. Using or programming a phone while driving, even with Bluetooth enabled, can result in serious injury or death.

Warning: Follow all applicable laws regarding the use of phones while driving, including, but not limited to, laws that prohibit texting and require hands-free operation at all times.



Overview

The Google Maps™ application provides the navigation functions in the Model X.

- If Model X is equipped with the Navigation option, the application is labeled **Nav**, and onboard maps are available. Onboard maps allow you to navigate to any location, even if a data connection is not available, but you must enter the location's exact and complete address.
- If Model X is not equipped with the Navigation option, onboard maps are not available, but if you have a data connection, you can find and display any location.

When you specify a location, the touchscreen displays the route and provides turn-by-turn directions. Each turn is preceded by the distance to the maneuver. If you won't have enough energy, and there is no Supercharger on the route, an alert at the top of the turn-by-turn directions tells you that charging is required to reach your destination.

If the energy remaining after a round-trip is less than ten percent, or if a round trip will consume a significant amount of battery energy, a round trip estimate of the energy you will use displays at the bottom of the turn-by-turn directions. You can display a round trip energy estimate for all trips, regardless of battery energy used, by selecting **Always Show Estimated Round Trip Energy** in the settings for Maps and Navigation. When enabled, the round trip energy estimate will always display at the bottom of the turn-by-turn directions. (You may need to scroll to the bottom of the turn-by-turn directions to see the round trip energy estimate.)

Using Maps

Touch **Navigate**, or speak a voice command (see [Using Voice Commands](#) on page 46), to specify a location. You can enter or speak an address, landmark, business, etc. You can also touch **Navigate** and choose from Home and Work locations, a list of favorite destinations (see [Favorite, Home, and Work Destinations](#) on page 141), recent locations and searches (the most recently used locations display at the top), and charging stations you have visited.

When you touch the pin for a location, landmark, or business in the Recent or Favorites list, or touch a pin on the map, the chosen location is centered on the map, and a popup that provides more information about the location is displayed. In the popup, the name, phone number, and address of the location, landmark, or business is displayed. Any of the following information may also be displayed: its Google rating, its price range, whether it's open or closed, and whether it has chargers, Wi-Fi, restrooms, and food.

From this popup window, you can save the location as a favorite, and, if equipped with the Navigation option, navigate to the destination by touching **Navigate**, or call someone at the location by touching **Call**. If equipped with the Navigation option, when you touch the name of a location in the Recent or Favorites list (versus touching its pin), you can initiate navigation immediately. Model X calculates the route and displays turn-by-turn directions.

By default, the map displays Supercharger locations (see [Charging Locations](#) on page 139). If Model X is equipped with the Navigation option, you can drop a pin anywhere on the map by pressing and holding a location on the map.

Use the icons in the lower right corner to customize what the map displays:



Satellite Imagery - touch to turn satellite imagery on and off.



Traffic - touch to turn the display of traffic on and off. To ensure that heavy traffic areas are easy to identify along a navigation route, green traffic lines display under the blue route line, whereas yellow and red traffic lines display on top.



Charging locations - touch to display charging locations on the map and in a popup list that includes city and proximity (see [Charging Locations](#) on page 139).

Note: The popup list displays the straight line distance to the location, not the driving distance to the location. When you begin navigating, the navigation system displays the driving distance to the location.



Touch the zoom icons in the top right area to zoom the map in and out on your current or chosen location. Touch the North/Heading Up icon to center the map on your current location and change the orientation of the map:



North Up - North is always at the top of the screen.



Heading Up - The direction you are heading is always at the top of the screen. The map rotates when you change direction. This icon has an integrated compass that indicates the direction you are driving.

You can rotate the map in any direction using your fingers. When you rotate the map in a clockwise or counter-clockwise direction, or move the map up, down, left, or right, the North/Heading Up icon turns gray and no longer tracks your position. (The message "Tracking Disabled" is displayed next to the North/Heading Up icon.) To re-enable tracking, and adjust the orientation of the map so that North, or the direction you are traveling, is at the top of the screen, touch the North/Heading Up icon again. The North/Heading Up icon is reenabled, and the message, "North Up" or "Heading Up" is displayed.

Note: To keep tracking enabled, zoom in or out using only the zoom icons or by pinching your fingers. To disable tracking, move the map in any direction.

To maximize the size of the map, the touchscreen's status bar and app area, as well as the icons on the map, disappear after a few seconds. Simply touch the map to redisplay them.

Charging Locations

Superchargers are displayed on the map by default, represented by red pins that you can touch to display more information about the Supercharger location, navigate to it, or mark it as a favorite. When you touch the pin for a Supercharger location on the map, information about the Supercharger location is displayed, including the total number of Superchargers, the number of Superchargers available, the address of the Supercharger, and its approximate distance from you. The popup also displays any amenities that are available at the Supercharger location, including restrooms, restaurants, lodging, shopping, and Wi-Fi availability.

Note: The popup displays the straight line distance to the charger location, not the driving distance to the charger location. When you begin navigating, the navigation system displays the driving distance to the charger location.

In addition to Superchargers, you can display destination chargers and charging stations that you used before by touching the charging icon in the lower right corner of the map. Display details about any charging location by touching its pin:



The Supercharger location is operational.



The Supercharger location may be out of operation or is operating at a reduced capacity (touch the pin to display details).



The location is equipped with a charging station (Wall Connector). Touch to display more information, such as the charging station's capacity and usage restrictions.



The location is equipped with more than one charging station. The number on the icon indicates how many charging stations are located at the destination. Zoom in to display the pin for each charging station (described above).

Starting Navigation

1. Touch the **Nav** app to display the map.
2. Touch **Navigate** and enter a destination. You can also use voice commands (see



Steering Wheel on page 44), touch a location in the **Recent** or **Favorites** list, or touch a pin on the map, and then touch **Navigate** from the popup.

- If you have a data connection, you can start entering the destination, then choose one of the auto-complete entries that appear in the popup list. For example, you can enter just the street, business name, or category (such as hotels, coffee, etc.).

Note: The popup list displays the straight line distance to the location, not the driving distance to the location. When you begin navigating, the navigation system displays the driving distance to the location.

- If you don't have a data connection, touch **Navigate**, touch the **Search Entry** to use the onboard maps. Enter the complete address, and then touch **Find**.

Note: If a connected phone's calendar is set up to work with Model X, and a calendar event includes a specific location, you can initiate navigation from the calendar (see [Calendar](#) on page 143).

During Navigation

During navigation, the touchscreen displays a turn-by-turn direction list that includes estimated mileage, driving time, arrival time, and an estimate of how much energy is remaining when you reach the destination.

Note: If Model X requires charging to reach the destination and Trip Planner is turned on (see [Trip Planner](#) on page 141), the navigation route includes Supercharger stops.

The touchscreen also displays your location on the map. Depending on the map's zoom level, you might not be able to see the entire route. Whenever a navigation route is active, you can display the full route on the map by touching the route overview icon:



The route overview icon is available in the top right corner of the map whenever a navigation route is active. You can touch this icon to display the current leg of your trip or to change the orientation of the map to North Up or Heading Up (see [Using Maps](#) on page 138).

During navigation, the instrument panel displays the turn-by-turn directions, and you will also hear spoken directions. To change the volume of the spoken directions, use the scroll wheel on the left side of the steering wheel while navigation directions are being spoken. You can also change or mute the volume by touching the volume icon located in the top right corner of the turn-by-turn direction list.

Model X detects real-time traffic conditions and automatically adjusts the estimated driving and arrival times based on traffic. In situations where traffic conditions will delay your estimated time of arrival and an alternate route is available, Model X reroutes you to your destination. You can turn this feature off by touching **Controls** > **Settings** > **Apps** > **Maps & Navigation** > **Traffic-Based Routing** > **Off**. You can specify the amount of time savings (in minutes) that must be achieved before you are rerouted by touching the arrows associated with the **Re-Route If It Saves More Than** setting.

Model X can also monitor traffic to your work location (on weekday mornings) and to your home location (on weekday evenings) and advise you if there is a better route in situations where traffic conditions will cause a delay by touching **Controls** > **Settings** > **Apps** > **Maps & Navigation** > **Show Commute Advice** > **ON**. You can specify that commute advice be given only when a faster route is available by selecting **Only when a faster route is available**.

Note: Traffic-Based Commute Advice is only available if your Model X is equipped with the Navigation option and you have saved Home and Work locations.

Model X can route you around ferries and tolls. Touch **Controls** > **Settings** > **Apps** > **Maps & Navigation**, and then touch the associated check boxes.

As you approach an upcoming turn on your navigation route, a vertical progression bar displays on the right side of the touchscreen's turn-by-turn direction list. This vertical bar also displays on the right side of the navigation instructions on the instrument panel. As you progress toward the location where you will need to make a turn, the bar fills, from bottom to top. When you arrive at the location of the turn, the bar is completely filled.



Predicting Energy Usage

When navigating to a destination, Model X helps you anticipate your charging needs by calculating the amount of energy that will remain when you reach your destination. The calculation is an estimate based on driving and environmental factors such as predicted speed and elevation changes. The touchscreen displays this calculation at the bottom of the turn-by-turn direction list when you first initiate the navigation route. Thereafter, you can display it by touching the area at the bottom of the turn-by-turn direction list.

Throughout your route, Model X monitors energy usage and updates the calculation as needed. A popup warning displays at the bottom of the turn-by-turn direction list in these situations:

- A yellow warning displays when you have very little energy remaining to reach your destination and should drive slowly to conserve energy. For tips on conserving energy, see [Getting Maximum Range](#) on page 71.
- A red warning displays when you must charge Model X to reach your destination.

If you select **Always Show Estimated Round Trip Energy** in the Navigation settings, Model X also lets you know if you have enough energy for a round trip at the bottom of the turn-by-turn directions. By default, an estimate of your round trip energy usage displays at the bottom of the turn-by-turn directions when the remaining battery energy is estimated at less than ten percent after completion of the round trip, or when the round trip consumes a significant amount of your energy.

When navigating, you can also use the Energy app to monitor energy usage while on your trip (see [Getting Maximum Range](#) on page 71).

Trip Planner

Trip Planner helps you take longer road trips with confidence. If reaching your destination requires charging, Trip Planner routes you through the appropriate Supercharger locations. Trip Planner selects a route that minimizes the time you spend driving and charging. To use Trip Planner, touch **Controls** > **Settings** > **Apps** > **Maps and Navigation** > **Trip Planner** > **On**.

After you select a destination, Trip Planner zooms out to give you an overview of your trip. As you begin your trip, Trip Planner zooms in to start navigation. The turn-by-turn directions include:

- The list of Supercharger stops (Trip Planner does not consider charging locations that are not Superchargers).
- The charging time required at each Supercharger stop.
- The estimated amount of energy available when you arrive at the first Supercharger location.

Note: You can scroll down the list (or zoom out on the map) to see the next Supercharger location on your trip. Trip Planner estimates how much time you will need to charge at each location.

While charging at a Supercharger stop, the charging screen displays the remaining charge time needed for your trip. If you charge for a shorter or longer length of time, the charge time for subsequent stops are readjusted.

Note: If a Supercharger located on your existing route experiences an outage, Trip Planner displays a notification and reroutes you to a different Supercharger location.

If Trip Planner estimates that you won't have enough energy for your round trip, and there is no Supercharger stop on your route, Trip Planner displays an alert at the top of the turn-by-turn directions and an empty battery icon with the amount of additional energy needed for your trip at the bottom of the turn-by-turn directions.

Favorite, Home, and Work Destinations



Add any destination to your Favorites list by either touching its pin while navigating to it, or by displaying it on the map and then touching its pin. In the popup dialog that appears, touch the Favorites icon, and then touch **Add to Favorites**. To remove a favorite destination, select it on the map, touch the **Favorites** icon in the popup that displays, and confirm deletion of the favorite by touching **Delete**.



If you frequently drive to a destination, you may want to add it as a Favorite to avoid having to enter the location's name or address each time. When you add a destination as a Favorite, you can easily navigate to it by touching **Navigate** > **Favorites** and then selecting it from the list.

The Navigate option also has placeholders for your Home and Work locations. Based on your usage patterns, Model X may prompt you to save a current location as Home or Work. After you save a Home and a Work location, Model X may prompt you to navigate to your Work location in the mornings and to your Home location in the evenings and tell you how long it will take to navigate in current traffic conditions. To navigate to your Work or Home location, simply press **NAV TO WORK** or **NAV TO HOME** when prompted. You can also touch **Controls** > **Settings** > **Apps** > **Maps & Navigation** and specify an amount of time to be saved (up to 30 minutes) before Model X re-routes your drive.

To edit Home and Work locations (or any location), touch **Navigate**, press and hold your Home or Work location, and enter a new address in the popup. You can also delete any location in the Recent or Favorites list by pressing and holding the location, and then touching its associated **X**.

Note: For security reasons, if you sell Model X, erase your Home and Work locations, and your favorite destinations (see [Erasing Personal Data](#) on page 122).

Updated Maps

To receive updated maps, periodically connect Model X to a Wi-Fi network (see [Connecting to Wi-Fi](#) on page 147). As updated maps become available, they are sent to Model X over Wi-Fi only. The touchscreen displays a message informing you when new maps have been installed.



Overview

The Calendar app allows you to view your phone's (iPhone® or Android™) calendar for the current and next day. The Calendar app requires that:

- The Tesla Model X mobile app is running and you are logged in. When prompted on your phone, you must grant calendar access to the mobile app. The mobile app can then periodically (and automatically) send calendar data from your phone to Model X. Also, whenever you display the mobile app on your phone, updated calendar data is sent to Model X. To ensure you have access to all features of the Calendar app, you will need the latest version of the mobile app.
- Your phone is connected to Model X via Bluetooth (for privacy reasons, calendar data displays only from a phone that is connected via Bluetooth).
- Remote access to Model X is turned on (touch **Controls > Settings > Safety & Security > Remote Access > On**).
- Both your phone and Model X have good connectivity.

When you enter Model X, the touchscreen can display a reminder of the day's events. You can customize if and when your calendar events are displayed by touching **Controls > Settings > Apps > Calendar > Show Calendar Upon Entry**.

To view scheduled events for the next 48 hours, choose the Calendar app from the main touchscreen window. The Calendar app displays events in chronological order.

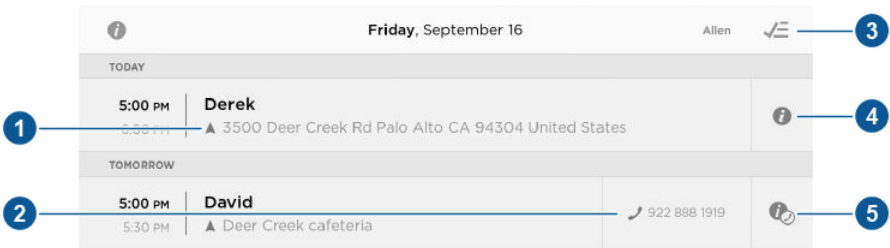

1. If the calendar event includes an address, a navigation arrow displays to indicate that you can touch the address to navigate to the event's location (if your Model X is equipped with Navigation).
2. If a phone number is associated with a calendar event, you can touch the number to initiate a phone call.
3. In situations where events are displayed from multiple calendars, you can filter to show only events from one or more specific calendars.
4. If the calendar event has notes associated with it, touch the information icon to display the notes in a popup window.
5. If an event's notes include one or more phone numbers, a phone symbol displays with the information icon and the first phone number found in the notes displays on the event list and you can use this number to initiate a phone call (as described in item 2 above). But you can also initiate a call from within the notes popup window by referencing other numbers that are included in the notes (this is particularly useful for conference calls). If the notes contain a web link, you can touch the link to open it in the Web Browser app.

Calendar and Navigation

If Model X is equipped with navigation, and a calendar event has a location specified, you will be given the option to navigate to that location. Also, when an event on your Calendar takes place within the next hour and has a uniquely specified location, the Model X navigation system notifies you if there is a better route due to traffic, even if you're not using navigation.



About the Security System

If Model X does not detect a key nearby and a locked door or trunk is opened, an alarm sounds and the headlights and turn signals flash. To deactivate the alarm, press any button on the key.

To manually enable or disable the alarm system, touch **Controls** > **Settings** > **Safety & Security** > **Alarm**. When set to **ON**, Model X activates its alarm one minute after you exit, the doors lock, and a recognized key is no longer detected.



About HomeLink

You can program the HomeLink® Universal Transceiver (if equipped) to operate up to three Radio Frequency (RF) devices, including garage doors, gates, lights, and security systems.

Note: Depending on date of manufacture, options selected, and time of purchase, some Model X vehicles are not equipped with HomeLink.

Programming HomeLink

1. Park Model X in front of the device you want to program, and have the device's remote control ready.

Note: Make sure you haven't reached the limit of learned remotes/vehicles. Most device receivers can learn up to five remotes/vehicles. If necessary, clear the receiver memory and restart the programming process. For information about clearing the receiver memory, refer to the owner documentation for your device.

2. On the touchscreen, touch **Controls > Settings > HomeLink**.
3. Touch **Add New HomeLink**, then use the onscreen keyboard to enter a name for your HomeLink device.
4. Touch **Program**.
5. Follow the onscreen instructions.

Once programmed, you can operate the device by touching its corresponding HomeLink icon on the touchscreen's status bar. HomeLink remembers the location of your programmed devices. When you approach a known location, the HomeLink control on the touchscreen automatically drops down. When you drive away, it disappears.

Note: For security reasons, delete your HomeLink devices if you sell your Model X (see [Deleting a Device](#) on page 145).

- ⚠ Warning:** Your device might open or close during programming. Before programming, make sure that the device is clear of any people or objects.
- ⚠ Warning:** Do not use the HomeLink Universal Transceiver with a device that does not have safety stop and reverse features. Using a device without these safety features increases the risk of injury or death.

Auto Opening and Closing

To operate a HomeLink device without touching the touchscreen, you can automate the device to open as you approach and close as you drive away:

- Touch **Controls > Settings > HomeLink** and choose the device you want to automate.
- Select the **Auto-open when arriving** checkbox.
- Touch the arrows to specify the distance you want your vehicle to be from the device before it opens.
- Select the **Auto-close when leaving** checkbox if you want the device to close as you drive away.

As you approach (or drive away from) a device that is set to operate automatically, the HomeLink status icon displays a count-down message to let you know when the device will automatically open. In situations where you don't want the device to automatically open or close, touch **Skip Auto-Open** or **Skip Auto-Close** at any time during the count-down message.

Resetting the Location of the HomeLink Device

If you experience situations in which you sometimes drive up to your HomeLink device and it doesn't open, or the HomeLink icon on the touchscreen's status bar does not display the dropdown when you approach the device, you may need to reset the device's location. To do so, park as close as possible to the HomeLink device (garage door, gate, etc.) and display the HomeLink settings page by touching **Controls > Settings > HomeLink**. Touch the name of the device you want to reset, then **Reset Location**.

Deleting a Device

To delete a HomeLink device, touch **Controls > Settings > HomeLink**. Touch the name of the device you want to delete, then touch **Delete**.

Note: You can also perform a factory reset to erase your HomeLink settings, along with all other personal data (saved addresses, music favorites, imported contacts, etc.). See [Erasing Personal Data](#) on page 122.



Troubleshooting HomeLink

When programming a HomeLink device, the touchscreen walks you through a two-part programming process:

1. Model X records the signal from the remote. The touchscreen instructs you to stand in front of the vehicle, point the remote at the front bumper and press and hold the button until the headlights flash. When the headlights flash, Model X has learned the remote and you can touch **Continue** on the touchscreen. If the headlights do not flash, refer to the following guidelines.
2. The device's receiver learns Model X. The touchscreen instructs you to press the **LEARN** button on the device's receiver. If training the receiver does not work, refer to the following guidelines.

Note: Only devices that are equipped with a "rolling code" remote need to learn Model X. If you have an old device that is not equipped with a "rolling code" remote, the device does not need to learn Model X and you can skip this part of the process. You can also skip this part if your receiver is "Quick-Train" compatible.

Headlights do not flash

- Check the batteries in the remote. It is a good idea to replace the batteries before you start programming.
- Hold the remote against the front bumper, with the button pressed, approximately 6 in (15 cm) to the left of the Tesla emblem. In some cases you must hold the button on the remote for up to three minutes.
- Check compatibility of the remote by contacting the HomeLink manufacturer (www.homelink.com).

After programming, the device does not work

- Park Model X with its front bumper as close as possible to the HomeLink device (garage door, gate, etc.).
- Make sure you haven't reached the device receiver's limit of learned remotes/cars. Most receivers can learn up to five remotes/cars. If the receiver's memory is full, you must clear the memory and restart the programming process. For instructions on how to clear the receiver's memory, refer to the owner documentation provided with the HomeLink device.

- Make sure you are pressing the receiver's **LEARN** button. Most receivers have two buttons and a LED. One button is a **RESET** button and the other is a **LEARN** button. Pressing the **LEARN** button usually causes the LED to flash. For instructions on how to put the receiver into learning mode, refer to the owner documentation provided with the HomeLink device.
- Most devices stay in learning mode for only three to five minutes. Immediately after pressing the device's **LEARN** button, follow the instructions displayed on the touchscreen.



Wi-Fi is available as a data connection method and is often faster than cellular data networks. Connecting to Wi-Fi is especially useful in areas with limited or no cellular connectivity. To ensure fast, reliable delivery of Model X updates (see [Software Updates](#) on page 148), Tesla recommends leaving Wi-Fi turned on and connected to a Wi-Fi network. To connect to a Wi-Fi network:

1. Touch the **LTE** (or **3G**) icon in the touchscreen status bar. Model X will start scanning and display the Wi-Fi networks that are within range.
2. Select the Wi-Fi network you want to use, enter the password (if necessary), then touch **Connect**.

You can also connect to a hidden network that isn't shown on the list of scanned networks. Just touch **Wi-Fi Settings** and enter the name of the network in the resulting dialog box.

Once you have connected to a network, Model X automatically connects whenever the network is within range. If more than one previously connected network is within range, Model X connects to the one most recently used.

Note: You can also use a mobile hotspot or your phone's Internet connection via Wi-Fi tethering.

Note: At Tesla Service Centers, Model X automatically connects to the Tesla Service Wi-Fi network.



Loading New Software

Model X updates its software wirelessly, providing new features throughout your term of ownership. Tesla recommends that you install software updates as soon as they are available. The first time you enter Model X after an update is made available, a scheduling window displays on the touchscreen. The scheduling window displays again at the end of your first driving session.

Note: Some software updates can take up to three hours to complete. Model X must be in Park while the new software is being installed. To ensure the fastest and most reliable delivery of software updates, leave the Wi-Fi turned on and connected whenever possible (see [Connecting to Wi-Fi](#) on page 147).

When a software update is available, a yellow clock icon appears on the touchscreen's status bar. Touch this clock icon to display the update window. You can then either:

- Schedule the update by setting the time you want the update to begin. Then touch **Set For This Time**. Once scheduled, the yellow clock icon changes to a white clock icon. You can reschedule the update any time before it begins.

OR

- Touch **Install Now** to immediately start the update process.

If Model X is charging when the software update begins, charging stops. Charging resumes automatically when the software update is complete. If you are driving Model X at the scheduled update time, the update is canceled and you need to reschedule it.

Note: Over time, the touchscreen may display a software update window informing you to **SET FOR THIS TIME** or **INSTALL NOW**. This software update window will persist until you complete the installation of the software update. You must install all software updates as soon as they are available and any harm relating to the failure to install a software update will not be covered by the vehicle's warranty. Failure or refusal to install such updates may result in the inaccessibility of certain vehicle features (including incompatibility with digital media devices) or in Tesla being unable to diagnose and service your vehicle.

Note: If software updates are not installed, some vehicle features may become inaccessible and digital media devices may

become incompatible. Reverting to a previous software version is not possible.

If the touchscreen displays a message indicating that a software update was not successfully completed, contact Tesla.

Viewing Release Notes

When a software update is complete, learn about the new features by reading the release notes. To display release notes about your current software version at any time touch the Tesla "T" at the top center of the touchscreen, then touch **Release Notes**.

Tesla strongly recommends reading all release notes. They may contain important safety information or operating instructions regarding your Model X.



Model X Mobile App

The Tesla Model X mobile app allows you to communicate with Model X remotely using your iPhone¹ or Android™ phone. With this app, you can:

- View the vehicle's estimated range.
- Check charging progress or stop charging and receive notifications when charging has started, has been interrupted, is nearing completion, or is complete.

Note: If Supercharging, additional notifications will alert you when idle fees are incurred. The idle fees are waived if your vehicle is moved within five minutes of when you finish charging. See [Supercharger Usage Fees and Idle Fees](#) on page 158.

- Check the interior temperature and heat or cool Model X before driving (even if it's in a garage).
- Locate Model X with directions, or track its movement across a map.
- Flash lights or honk the horn to find Model X when parked.
- Lock or unlock Model X from afar.
- Open the front or rear trunks.
- Enable valet mode.
- Allow Model X to be started remotely.
- Park or unpark Model X using Summon (see [Using Summon](#) on page 99).
- Support the Model X Calendar app by allowing the mobile app to send your phone's calendar data to Model X.
- Receive notifications when the car alarm has been triggered, or a new Model X software update is available.
- Receive notifications of scheduled software updates.
- View the odometer, VIN, and current software version.

Simply download the Tesla Model X mobile app to your phone and enter your Tesla Account login credentials. You must also ensure that Model X is ready to communicate with the mobile app by turning on its remote access setting. Touch **Controls > Settings > Safety & Security > Remote Access > On** (see [Settings](#) on page 119).

Note: Tesla does not support the use of third party applications to contact Model X.

Note: To ensure access to new and improved features, download updated versions of the mobile app as they become available.



High Voltage Components

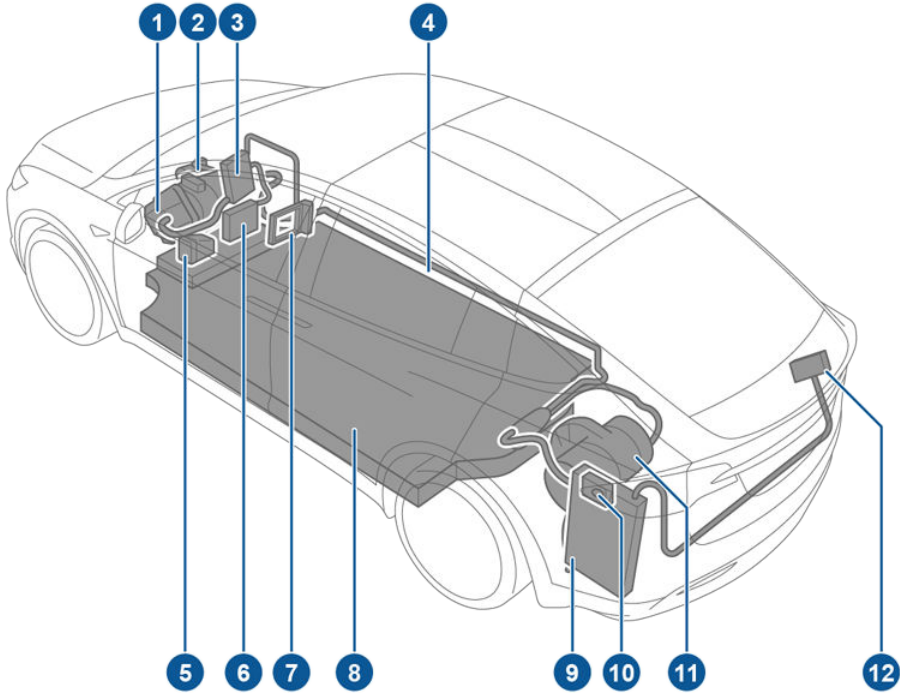

1. Front Motor
2. Air Conditioning Compressor
3. Forward Junction Box
4. High Voltage Cabling
5. Battery Coolant Heater
6. DC-DC Converter
7. Cabin Heater
8. High Voltage Battery
9. On-board Charger
10. Charge Port
11. Rear Motor
12. HV Cable to Rear HVAC Assembly

- Warning:** The high voltage system has no user serviceable parts. Do not disassemble, remove or replace high voltage components, cables or connectors. High voltage cables are typically colored orange for easy identification.
- Warning:** Read and follow all instructions provided on the labels that are attached to Model X. These labels are there for your safety.
- Warning:** In the unlikely event that a fire occurs, immediately contact your local fire emergency responders.



Charging Equipment

Charging equipment designed specifically to charge your Model X is available from Tesla. A Tesla Wall Connector, which installs in your garage, is the fastest way to charge Model X at home.

In several market regions, Model X is equipped with a Mobile Connector and the adapter(s) you need to plug into commonly used power outlets. When using the Mobile Connector, first plug the Mobile Connector into the power outlet, and then plug in Model X. For more information about your Mobile Connector, see the Mobile Connector Owner's Manual (available on the touchscreen). Additional adapters can be purchased from Tesla.

Tesla also offers various adapters that allow you to plug Model X into the most commonly used public charging stations in your region. Connect the adapter to the charging station's charge cable, open the charge port door using the touchscreen (see [Charging Instructions](#) on page 154), and then plug in Model X.

For more information on the charging equipment available for your region, go to www.tesla.com, choose your region, and then view the available charging options.



About the Battery

Model X has one of the most sophisticated battery systems in the world. The most important way to preserve the Battery is to **LEAVE YOUR VEHICLE PLUGGED IN** when you are not using it. This is particularly important if you are not planning to drive Model X for several weeks. When plugged in, Model X wakes up when needed to automatically maintain a charge level that maximizes the lifetime of the Battery.

There is no advantage to waiting until the Battery's level is low before charging. In fact, the Battery performs best when charged regularly.

Note: If the Model X Battery becomes completely discharged in a situation in which towing is required, the owner is responsible for towing expenses. Discharge-related towing expenses are not covered under the Roadside Assistance policy.

The peak charging rate of the Battery may decrease slightly after a large number of DC Fast Charging sessions, such as those at Superchargers. To ensure maximum driving range and Battery safety, the Battery charge rate is decreased when the Battery is too cold, when the Battery's charge is nearly full, and when the Battery conditions change with usage and age. These changes in the condition of the Battery are driven by battery physics and may increase the total Supercharging duration by a few minutes over time.

Battery Care

Never allow the Battery to fully discharge. Even when Model X is not being driven, its Battery discharges very slowly to power the onboard electronics. On average, the Battery discharges at a rate of 1% per day. Situations can arise in which you must leave Model X unplugged for an extended period of time (for example, at an airport when traveling). In these situations, keep the 1% in mind to ensure that you leave the Battery with a sufficient charge level. For example, over a two week period (14 days), the Battery discharges by approximately 14%.

Discharging the Battery to 0% may permanently damage the Battery. To protect against a complete discharge, Model X enters a low-power consumption mode when the charge level drops to 5%. In this mode, the Battery stops supporting the onboard electronics to slow the discharge rate to approximately 4% per month. Once this low-power consumption mode is active, it is important to plug in Model X within two months to avoid Battery damage.

Note: When the low-power consumption mode is active, the auxiliary 12V battery is no longer being charged and can completely discharge within 12 hours. In the unlikely event that this occurs, you may need to jump start or replace the 12V battery before you can charge. In this situation, contact Tesla.

Temperature Limits

For better long-term performance, avoid exposing Model X to ambient temperatures above 140° F (60° C) or below -22° F (-30° C) for more than 24 hours at a time.

Energy Saving Feature

Model X has an energy-saving feature that reduces the amount of energy being consumed when Model X is not in use. Touch **Controls > Displays > Energy Saving**. For more information on maximizing range and saving energy, see [Getting Maximum Range](#) on page 71.

Battery Warnings and Cautions

Warning: The Battery has no parts that an owner or a non-Tesla authorized service technician can service. Under no circumstances should you open or tamper with the Battery. Always contact Tesla to arrange for Battery servicing.

Caution: If the Battery's charge level falls to 0%, you must plug it in. If you leave it unplugged for an extended period, it may not be possible to charge or use Model X without jump starting or replacing the 12V battery. Leaving Model X unplugged for an extended period can also result in permanent Battery damage. If you are unable to charge Model X, contact Tesla immediately.

Caution: The Battery requires no owner maintenance. Do not remove the coolant filler cap and do not add fluid. If the instrument panel warns you that the fluid level is low, contact Tesla immediately.



 **Caution:** Do not use the Battery as a stationary power source. Doing so voids the warranty.



Opening the Charge Port

The charge port is located on the left side of Model X, behind a door that is part of the rear tail light assembly. Park so that the charge cable easily reaches the charge port.

With Model X unlocked (or a recognized key is within range) and in Park, press and release the button on the Tesla charge cable to open the charge port door.



You can also open the charge port door using any of these methods:

- On the touchscreen, touch **Controls** > **Charging** > **Open Charge Port**.
- Touch the charging icon in the status bar on the top of the touchscreen, then press **Open Charge Port**.
- On the key, hold down the rear trunk button for 1-2 seconds.
- Press the charge port door when Model X is unlocked or a recognized key is nearby.

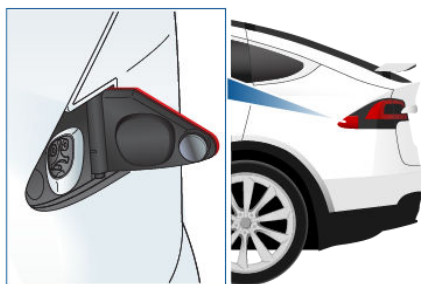

Note: The charge port lights up white when you open the charge port door. If you do not insert a charge cable into the charge port within a few minutes after opening the charge port door, the charge port door closes. If this happens, use the touchscreen to open the charge port door again.

Caution: Do not try to force the charge port door open.

Plugging In

If desired, use the touchscreen to change the charge limit and the charging current (see [Changing Charge Settings](#) on page 155).

To charge at a public charging station, attach an adapter to the station's charging connector. The most commonly used adapter(s) for each market region are provided. Depending on the charging equipment you are using, you may need to start and stop charging using a control on the charging equipment.

If you are using the Mobile Connector, plug it into the power outlet before plugging it into Model X.

Align the connector to the charge port and insert fully. When the connector is properly inserted, charging begins automatically after Model X:

- Engages a latch that holds the connector in place;
- Shifts into Park (if it was in any other gear);
- Heats or cools the Battery, if needed. If the Battery requires heating or cooling, you may notice a delay before charging begins.

Note: Whenever Model X is plugged in but not actively charging, it draws energy from the wall outlet instead of using energy stored in the Battery. For example, if you are sitting in Model X and using the touchscreen while parked and plugged in, Model X draws energy from the wall outlet instead of the Battery.

Caution: The connector end of the charge cable can damage the paint if dropped onto the vehicle.

During Charging

During charging, the charge port light pulses green, and the instrument panel displays the charging status. The frequency at which the charge port light pulses slows down as the charge level approaches full. When charging is complete, the light stops pulsing and is solid green.

Note: If Model X is locked, the charge port light does not light up.



If the charge port light turns red while charging, a fault is detected. Check the instrument panel or touchscreen for a message describing the fault. A fault can occur due to something as common as a power outage. If a power outage occurs, charging resumes automatically when power is restored.

Note: When charging, particularly at high currents, the refrigerant compressor and fan operate as needed to keep the Battery cool. Therefore, it is normal to hear sounds during charging.

Note: Air conditioning performance is generally not affected by charging. However, under certain circumstances (for example, you are charging at high currents during a particularly warm day), the air coming from the vents may not be as cool as expected and a message displays on the instrument panel. This is normal behavior and ensures that the Battery stays within an optimum temperature range while charging to support longevity and optimum performance.

Warning: Never spray liquid at a high velocity (for example, if using a pressure washer) towards the charge port while charging. Failure to follow these instructions can result in serious injury or damage to the vehicle, charging equipment, or property.

Stopping Charging

Stop charging at any time by disconnecting the charge cable or touching **Stop Charging** on the touchscreen.

Note: To prevent unauthorized unplugging of the charge cable, Model X must be unlocked or able to recognize your key before you can disconnect the charge cable.

To disconnect the charge cable:

1. Press and hold the button on a Tesla connector to release the latch. You can also touch **Stop Charging** on the charging screen (see [Changing Charge Settings](#) on page 155).
2. Pull the connector from the charge port.
3. Push the charge port door closed.

Note: If Model X is equipped with a motorized charge port door, it automatically closes when you remove the charge cable.

Caution: Tesla strongly recommends leaving Model X plugged in when not in

use. This maintains the Battery at the optimum level of charge.

Charge Port Light

- **WHITE:** The charge port door is open. Model X is ready to charge and the connector is not inserted, or the latch is released and the connector is ready to be removed.
- **BLUE:** Model X detects that a connector has been plugged in, but charging has not started. Either Model X is preparing to charge, or a charging session is scheduled to begin at a specified future time.
- **BLINKING GREEN:** Charging is in progress. As Model X approaches a full charge, the frequency of the blinking slows.
- **SOLID GREEN:** Charging is complete.
- **SOLID AMBER:** The connector is not fully plugged in. Realign the connector to the charge port and insert fully.
- **BLINKING AMBER:** Model X is charging at a reduced current (AC charging only).
- **RED:** A fault is detected and charging has stopped. Check the instrument panel or touchscreen for a fault message.

Changing Charge Settings

The charge settings screen displays on the touchscreen whenever the charge port door is open.

To display charge settings at any time, touch the Battery icon on the top of the touchscreen, or touch **Controls > Charging** (located in the upper right portion of the Controls screen).

Note: The following illustration is provided for demonstration purposes only and may vary slightly depending on software version and market region.

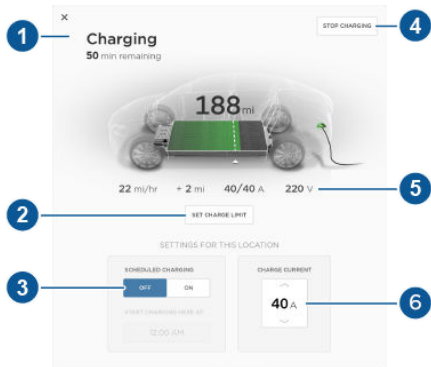

Note: If charging at a Tesla Supercharger, and paid supercharging is potentially in effect, the charging screen also displays information about your previous or current Supercharger session (see [Supercharger Usage Fees and Idle Fees](#) on page 158).

1. Charge status messages (such as Charging Scheduled, Charging In Progress) display here.
2. To adjust the charge limit, touch **Set Charge Limit**, and drag the arrow to change the charge limit setting. The setting you choose applies to immediate and scheduled charging sessions.
3. Location-specific schedule. With Model X in Park, set a specific time to begin charging at the current location. If, at the scheduled time, Model X is not plugged in at the location, charging starts as soon as you plug it in provided you plug it in within six hours of the scheduled time. If plugged in after six hours, charging does not start until the scheduled time on the next day. To override this setting, touch **Start Charging** or **Stop Charging** (see item 4). When you set a scheduled charging time, Model X displays the set time on the instrument panel and touchscreen.
4. Touch to open the charge port door or to start (or stop) charging.
5. Charging rate per hour, estimated increase in driving distance (or energy) achieved so far in this charging session, current supplied/available from the connected power supply, and voltage supplied by the charge cable.

6. The current automatically sets to the maximum current available from the attached charge cable, unless it was previously reduced to a lower level. If needed, touch the up/down arrows to change the current (for example, you may want to reduce the current if you are concerned about overloading a domestic wiring circuit shared by other equipment). It is not possible to set the charging current to a level that exceeds the maximum available from the attached charge cable. When you change the current, Model X remembers the location. If you charge at the same location, you do not need to change it again.

Note: If Model X automatically reduced the current at a charging location because of fluctuations in input power (see the note in [Charging Status](#) on page 157), Tesla recommends charging at the lower current until the underlying problem is resolved and the charging location can provide consistent power.



Charging Status

The following illustration is provided for demonstration purposes only and may vary slightly depending on the software version and market region.

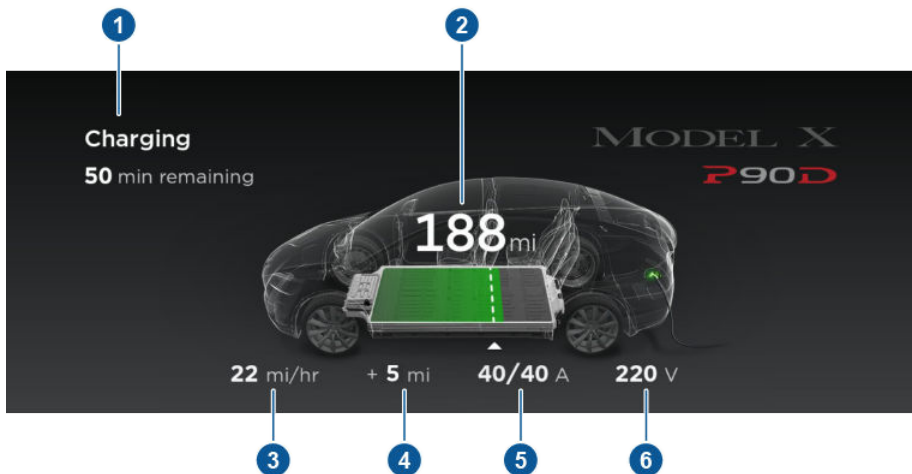

1. Charging status information. For example, when Model X is charging, it displays the time remaining until fully charged at the currently selected charge level. When a charging session is scheduled, it displays when charging starts.
2. Total estimated driving distance (or energy) available. To choose between displaying distance or energy percentage, touch **Controls > Settings > Units & Format > Energy & Charging**.

Note: A portion of the battery image may appear blue. This indicates that a small portion of the energy stored in the battery is not available because the battery is cold. This is normal and no reason for concern. When the battery warms up, the blue portion no longer displays.

3. Charging rate per hour.
4. Estimated increase in driving distance (or energy) achieved so far in this charging session.
5. Current supplied/available from the connected power supply (see [Changing Charge Settings](#) on page 155).
6. Voltage supplied by the charge cable.

Note: If Model X is charging and detects unexpected fluctuations in input power, the charging current is automatically reduced by 25%. For example, a 40 amp current is reduced to 30 amps. This automatic current reduction increases robustness and safety in situations when an external problem exists (for example, a home wiring system, receptacle, adapter or cord is unable to meet its rated current capacity). As a precaution, when Model X automatically reduces current, it saves the reduced current at the charging location. Although you can manually increase it, Tesla recommends charging at the lower current until the underlying problem is resolved and the charging location can provide consistent power.



Supercharger Usage Fees and Idle Fees

When charging using a Tesla supercharger, PAID SUPERCHARGING information displays at the bottom of the charging screen. This information includes the location, the time that charging started, and an estimate of how much the session will cost. When you stop charging, the final cost displays until a new Supercharging session begins. If free charging is applicable, the cost displays as zero.

When charging at a Tesla supercharger, you are subject to idle fees. Idle fees are designed to encourage drivers to move their vehicle from the Supercharger when charging is complete and are in effect whenever at least half of the Superchargers at a site are occupied. The Tesla mobile app notifies you when charging nears completion, and again when charging is complete. Additional notifications are sent if idle fees are incurred. Idle fees are waived if you move your vehicle within five minutes of charging completion.

Log into your Tesla Account to view fees and details about Supercharger sessions, track the remaining balance of free credits, set up a payment method, and make payments. Once a payment method is saved, fees are automatically paid from your account.



Service Intervals

Regular maintenance is the key to ensuring the continued reliability and efficiency of your Model X.

Maintain the correct tire pressures, and take Model X to Tesla at the regularly scheduled maintenance intervals of every 12 months, or every 12,500 miles (20,000 km), whichever comes first. It is also important to perform the daily and monthly checks described below.

Model X should be serviced by Tesla-certified technicians. Damages or failures caused by maintenance or repairs performed by non-Tesla certified technicians are not covered by the warranty.

Daily Checks

- Check the Battery's charge level, displayed on the instrument panel or mobile app.
- Check the condition and pressure of each tire (see [Tire Care and Maintenance](#) on page 160).
- Check that all exterior lights, horn, turn signals, and wipers and washers are working.
- Check the operation of the brakes, including the parking brake.
- Check the operation of the seat belts (see [Seat Belts](#) on page 27).
- Look for abnormal fluid deposits underneath Model X that might indicate a leak. It is normal for a small pool of water to form (caused by the air conditioning system's dehumidifying process).

Monthly Checks

- Check windshield washer fluid level and top up if necessary (see [Topping Up Washer Fluid](#) on page 171).
- Check that the air conditioning system is operating correctly (see [Climate Controls](#) on page 123).

⚠ Warning: Contact Tesla immediately if you notice any significant or sudden drop in fluid levels or uneven tire wear.

Fluid Replacement Intervals

Do not change or top up the Battery coolant or brake fluid. Tesla service technicians replace fluids at the regularly scheduled service intervals:

- Brake fluid. Every 2 years or 25,000 miles (40,000 km), whichever comes first.
- Battery coolant. Every 4 years or 50,000 miles (80,000 km), whichever comes first.

Note: Any damage caused by opening the Battery coolant reservoir is excluded from the warranty.

High Voltage Safety

Your Model X has been designed and built with safety as a priority. However, be aware of these precautions to protect yourself from the risk of injury inherent in all high-voltage systems:

- Read and follow all instructions provided on the labels that are attached to Model X. These labels are there for your safety.
- The high voltage system has no user-serviceable parts. Do not disassemble, remove or replace high voltage components, cables or connectors. High voltage cables are colored orange for easy identification.
- If a collision occurs, do not touch any high voltage wiring, connectors, or components connected to the wiring.
- In the unlikely event that a fire occurs, immediately contact your local fire emergency responders.

⚠ Warning: Always disconnect the charge cable before working underneath Model X, even if charging is not in progress.

⚠ Warning: Keep your hands and clothing away from cooling fans. Some fans operate even when Model X is powered off.

⚠ Warning: Some fluids (battery acid, Battery coolant, brake fluid, windshield washer additives, etc.) used in vehicles are poisonous and should not be inhaled, swallowed, or brought into contact with open wounds. For your safety, always read and follow instructions printed on fluid containers.



Maintaining Tire Pressures

If you are not towing a trailer, keep tires inflated to the pressures shown on the Tire and Loading Information label, even if it differs from the pressure printed on the tire itself. The Tire and Loading Information label is located on the center door pillar and is visible when the driver's door is open.

If you are towing a trailer, do not use the tire pressures printed on the Tire and Loading Information Label. Instead, refer to the tire pressures published in the towing topic (see [Towing and Accessories](#) on page 75).



The Tire Pressure indicator light on the instrument panel alerts you if one or more tires is under- or over-inflated.

The Tire Pressure indicator light does not immediately turn off when you adjust tire pressure. After inflating the tire to the recommended pressure, you must drive over 15 mph (25 km/h) for more than 10 minutes to activate the Tire Pressure Monitoring System (TPMS), which turns off the Tire Pressure indicator light.

If the indicator light flashes for one minute whenever you power on Model X, a fault with the TPMS is detected (see [TPMS Malfunction](#) on page 165).

You can display tire pressures on the instrument panel by choosing to display **Car Status** using the right or left steering wheel buttons (see [Using Left Steering Wheel Buttons](#) on page 44 or [Using Right Steering Wheel Buttons](#) on page 45). You can also choose whether you want to display tire pressures using BAR or PSI by touching **Controls > Settings > Units & Format > Tire Pressure**.

Checking and Adjusting Tire Pressures

Follow these steps when tires are cold and Model X has been stationary for over three hours:

1. Remove the valve cap.
2. Firmly press an accurate tire pressure gauge onto the valve to measure pressure.
3. If required, add or remove air to reach the recommended pressure.

Note: You can release air by pressing the metal stem in the center of the valve.

4. Re-check pressure using the tire gauge.
5. Repeat steps 3 and 4 as necessary until the tire pressure is correct.
6. Replace the valve cap to prevent dirt from entering. Periodically check the valve for damage and leaks.



Warning: Under-inflation is the most common cause of tire failures and can cause a tire to overheat, resulting in severe tire cracking, tread separation, or blowout, which causes unexpected loss of vehicle control and increased risk of injury. Under-inflation also reduces the vehicle's range and tire tread life.



Warning: Check tire pressures using an accurate pressure gauge when tires are cold. It takes only about one mile (1.6 km) of driving to warm up the tires sufficiently to affect tire pressures. Parking the vehicle in direct sunlight or in hot weather can also affect tire pressures. If you must check warm tires, expect increased pressures. Do not let air out of warm tires in an attempt to match recommended cold tire pressures. A hot tire at or below the recommended cold tire inflation pressure is dangerously under-inflated.



Warning: Do not use any tire sealant other than the type provided in a Tesla tire repair kit. Other types can cause tire pressure sensors to malfunction. If your Model X did not include a tire repair kit, you can purchase one from Tesla.



Inspecting and Maintaining Tires

Regularly inspect the tread and side walls for any sign of distortion (bulges), foreign objects, cuts or wear.

Warning: Do not drive Model X if a tire is damaged, excessively worn, or inflated to an incorrect pressure. Check tires regularly for wear, and ensure there are no cuts, bulges or exposure of the ply/cord structure.

Tire Wear

Adequate tread depth is important for proper tire performance. Tires with a tread depth less than 4/32" (3 mm) are more likely to hydroplane in wet conditions and should not be used. Tires with a tread depth less than 5/32" (4 mm) do not perform well in snow and slush and should not be used when driving in winter conditions.

Model X is originally fitted with tires that have wear indicators molded into the tread pattern. When the tread has been worn down to 4/32" (3 mm), the indicators start to appear at the surface of the tread pattern, producing the effect of a continuous band of rubber across the width of the tire. For optimal performance and safety, Tesla recommends replacing tires before the wear indicators are visible.

Tire Rotation, Balance, and Wheel Alignment

Model X tires cannot be rotated, as tires are asymmetrical and front tires are a different size from rear tires.

Unbalanced wheels (sometimes noticeable as vibration through the steering wheel) affect vehicle handling and tire life. Even with regular use, wheels can get out of balance. Therefore, they should be balanced as required.

If tire wear is uneven (on one side of the tire only) or becomes abnormally excessive, check the alignment of wheels.

Note: When replacing only two tires, always install the new tires on the rear.

Punctured Tires

A puncture eventually causes the tire to lose pressure, which is why it is important to check tire pressures frequently. Permanently repair or replace punctured or damaged tires as soon as possible.

Your tubeless tires may not leak when penetrated, provided the object remains in the tire. If, however, you feel a sudden vibration or ride disturbance while driving, or you suspect a tire is damaged, immediately reduce your speed. Drive slowly, while avoiding heavy braking or sharp steering and, when safe to do so, stop the vehicle. Arrange to have Model X transported to a Tesla Service Center, or to a nearby tire repair center.

Note: In some cases, you can temporarily repair small tire punctures (under 1/4" (6 mm)) using an optional tire repair kit available from Tesla. This allows you to slowly drive Model X to Tesla or to a nearby tire repair facility.

Warning: Do not drive with a punctured tire, even if the puncture has not caused the tire to deflate. A punctured tire can deflate suddenly at any time.

Flat Spots

If Model X is stationary for a long period in high temperatures, tires can form flat spots. When Model X is driven, these flat spots cause a vibration which gradually disappears as the tires warm up and regain their original shape.

To minimize flat spots during storage, inflate tires to the maximum pressure indicated on the tire wall. Then, before driving, release air to adjust tire pressure to the recommended levels.

Improving Tire Mileage

To improve the mileage you get from your tires, maintain tires at the recommended tire pressures, observe speed limits and advisory speeds, and avoid:

- Pulling away quickly, or hard acceleration.
- Fast turns and heavy braking.
- Potholes and objects in the road.
- Hitting curbs when parking.
- Contaminating tires with fluids that can cause damage.



Replacing Tires and Wheels

Tires degrade over time due to the effects of ultraviolet light, extreme temperatures, high loads, and environmental conditions. It is recommended that tires are replaced every six years, or sooner if required.

Wheel and tires are matched to suit the handling characteristics of the vehicle. Replacement tires must comply with the original specification. If tires other than those specified are used, ensure that the load and speed ratings marked on the tire (see [Understanding Tire Markings](#) on page 184) equal or exceed those of the original specification.

Ideally, you should replace all four tires at the same time. If this is not possible, replace the tires in pairs, placing the new tires on the rear. Always balance the wheel after replacing a tire.

If you replace a wheel, the TPMS (Tire Pressure Monitoring System) sensors need to be reset to ensure they provide accurate warnings when tires are under- or over-inflated (see [Automatic Resetting of TPMS Sensors](#) on page 164).

For the specification of the original wheels and tires installed on Model X, see [Wheels and Tires](#) on page 183.

Warning: For your safety, use only tires and wheels that match the original specification. Tires that do not match the original specification can affect the operation of the TPMS.

Warning: Never exceed the speed rating of your vehicle's tires. The speed rating is shown on the sidewall of your tires (see [Understanding Tire Markings](#) on page 184).

Asymmetric Tires

Model X tires are asymmetric and must be mounted on the wheel with the correct sidewall facing outward. The sidewall of the tire is marked with the word OUTSIDE. When new tires are installed, make sure that the tires are correctly mounted on the wheels.



Warning: Road holding is seriously impaired if the tires are incorrectly installed on the wheels.

Removing and Installing Lug Nut Covers

If your Model X is equipped with lug nut covers, you must remove them to access the lug nuts.

To remove a lug nut cover:

1. Insert the curved part of the lug nut cover tool (located in your glovebox) into the hole at the base of the Tesla "T".



2. Maneuver the lug nut cover tool so that it is fully inserted into the hole in the lug nut cover.
3. Twist the lug nut cover tool so that the curved part is touching the middle of the lug nut cover.
4. Firmly pull the lug nut tool away from the wheel until the lug nut cover is released.



To install the lug nut cover, align it into position and push firmly until it fully snaps into place.

Seasonal Tire Types

Summer Tires

Your Model X may be originally equipped with high performance summer tires, all season tires, or winter tires. Summer tires and all season tires are designed for maximum dry and wet road performance but are not designed to perform well in winter conditions. Tesla recommends using winter tires if driving in cold temperatures or on roads where snow or ice may be present. If not equipped with winter tires, contact Tesla for winter tire recommendations.

⚠ Warning: In cold temperatures or on snow or ice, summer tires do not provide adequate traction. Selecting and installing the appropriate tires for winter conditions is important to ensure the safety and optimum performance of your Model X, even when equipped with dual-motors.

All-Season Tires

Your Model X may be originally equipped with all-season tires. These tires are designed to provide adequate traction in most conditions year-round, but may not provide the same level of traction as winter tires in snowy or icy conditions. All-season tires can be identified by "ALL SEASON" and/or "M+S" (mud and snow) on the tire sidewall.

Winter Tires

Use winter tires to increase traction in snowy or icy conditions. When installing winter tires, always install a complete set of four tires at the same time. Winter tires must be the same size, brand, construction and tread pattern on all four wheels. Contact Tesla for winter tire recommendations.



Winter tires can be identified by a mountain/snowflake symbol on the tire's sidewall.

When driving with winter tires, you may experience more road noise, shorter tread life, and less traction on dry roads.



Driving in Low Temperatures

Tire performance is reduced in low ambient temperatures, resulting in reduced grip and an increased susceptibility to damage from impacts. Performance tires can temporarily harden when cold, causing you to hear rotational noise for the first few miles (kilometers) until the tires warm up.

Using Tire Chains

Tesla has tested and approved Maggie Group Trak Special LT51 tire chains to increase traction in snowy conditions. These chains should only be installed on rear 19 or 20" tires. Do not use chains on 22" tires or on front tires. The approved tire chains can be purchased from Tesla.

When installing tire chains, follow the instructions provided by the tire chain manufacturer. Mount them as tightly as possible.

When using tire chains:

- Drive slowly. Do not exceed 30 mph (48 km/h).
- Avoid heavily loading Model X (heavy loads can reduce the clearance between the tires and the body).
- Remove the tire chains as soon as conditions allow.

Note: Tire chains are prohibited in some jurisdictions. Check local laws before installing tire chains.

⚠️ Caution: Using non-recommended tire chains, or using tire chains on other sized tires can damage the suspension, body, wheels, and/or brake lines. Damage caused by using non-recommended tire chains is not covered by the warranty.

⚠️ Caution: Do not use chains on a Model X equipped with 22" tires and do not use tire chains on front tires.

⚠️ Caution: Ensure that the tire chains cannot touch suspension components or brake lines. If you hear the chains making unusual noises that would indicate contact with Model X, stop and investigate immediately.

Tire Pressure Monitoring

Each tire should be checked monthly when cold and inflated to the recommended pressures that are printed on the Tire and Loading Information label located on the driver's door pillar (see [Maintaining Tire Pressures](#) on page 160). If your vehicle has tires of a different size than the size indicated on the vehicle placard or tire inflation pressure label, determine the proper tire inflation pressure for those tires.

As an added safety feature, your vehicle has been equipped with a TPMS that displays a tire pressure telltale (Tire Pressure Warning) on the instrument panel when one or more of your tires is significantly under- or over-inflated. Accordingly, when the Tire Pressure indicator light displays on the instrument panel to alert you about tire pressure, stop and check your tires as soon as possible, and inflate them to the proper pressure (see [Maintaining Tire Pressures](#) on page 160). Driving on a significantly under-inflated tire causes the tire to overheat and can lead to tire failure. Under-inflation also reduces range efficiency and tire tread life, and may affect the vehicle's handling and stopping ability.



If Model X detects a fault with the TPMS, this indicator flashes for one minute whenever you power on Model X.

Note: Installing accessories that are not approved by Tesla can interfere with the TPMS.

⚠️ Warning: The TPMS is not a substitute for proper tire maintenance, including manually checking tire pressures and regularly inspecting the condition of tires. It is the driver's responsibility to maintain correct tire pressure, even if under- or over-inflation has not reached the level for the TPMS to trigger the Tire Pressure Warning on the instrument panel.

Automatic Resetting of TPMS Sensors

After replacing one or more wheels (but not after replacing a tire or rotating wheels), the TPMS sensors are reset to ensure tire pressure warnings are accurate. TPMS sensors reset automatically after driving over 15 mph (25 km/h) for longer than 10 minutes.

Note: After replacing a wheel, false tire pressure warnings may display before you've



driven 15 mph (25 km/h) for longer than 10 minutes.

Replacing a Tire Sensor

If the Tire Pressure warning indicator displays frequently, contact Tesla to determine if a tire sensor needs to be replaced. If a non-Tesla Service Center repairs or replaces a tire, the tire sensor may not work until Tesla performs the setup procedure.

TPMS Malfunction

Model X has also been equipped with a TPMS malfunction indicator to indicate when the system is not operating properly.



The TPMS malfunction indicator is combined with the tire pressure indicator light. When the system detects a malfunction, the indicator flashes for approximately one minute after Model X powers on, and then remains continuously lit. This sequence continues upon subsequent vehicle start-ups as long as the malfunction exists. When the TPMS malfunction indicator is on, the system might not be able to detect or signal under- and over-inflated tires as intended.

TPMS malfunctions can occur for a variety of reasons, including installing replacement or alternate tires or wheels that prevent the TPMS from functioning properly. Always check the TPMS malfunction indicator light after replacing one or more tires or wheels on your vehicle to ensure that the replacement tires or wheels allow the TPMS to continue to function properly.

Note: If a tire has been replaced or repaired using a different tire sealant than the one available from Tesla, and a low tire pressure is detected, it is possible that the tire sensor has been damaged. Contact Tesla to have the fault repaired as soon as possible.



Cleaning the Exterior

To prevent damage to the paint, immediately remove corrosive substances (bird droppings, tree resin, dead insects, tar spots, road salt, industrial fallout, etc.). Do not wait until Model X is due for a complete wash. If necessary, use denatured alcohol to remove tar spots and stubborn grease stains, then immediately wash the area with water and a mild, non-detergent soap to remove the alcohol.

Follow these steps when washing the exterior of Model X:

1. Rinse Thoroughly

Before washing, flush grime and grit from the bodywork using a hose. Flush away accumulations of mud in areas where debris easily collects (such as wheel arches and panel seams). If salt has been used on the highways (such as during winter months), thoroughly rinse all traces of road salt from the underside of the vehicle.

2. Hand Wash

Hand wash Model X using a clean soft cloth and cold or lukewarm water containing a mild, high-quality car shampoo.

3. Rinse with Clean Water











After washing, rinse with clean water to prevent soap from drying on the surfaces.

4. Dry Thoroughly and Clean Exterior Glass

After washing and rinsing, dry thoroughly with a chamois.

Clean windows and mirrors using an automotive glass cleaner. Do not scrape, or use any abrasive cleaning fluid on glass or mirrored surfaces.

Cautions for Exterior Cleaning

-  **Caution:** Do not use windshield treatment fluids. Doing so can interfere with wiper friction and cause a chattering sound.
-  **Caution:** Do not use hot water or detergents.
-  **Caution:** Do not wash in direct sunlight.
-  **Caution:** If using a pressure washer, maintain a distance of at least 12" (30 cm) between the nozzle and the surface of Model X. Keep the nozzle moving and do not concentrate the water jet on any one area.
-  **Caution:** Do not aim water hoses directly at window, door or hood seals, or through wheel apertures onto brake components.
-  **Caution:** Avoid using tight-napped or rough cloths, such as washing mitts.
-  **Caution:** If washing in an automatic car wash, use Touchless car washes only. These car washes have no parts (brushes, etc.) that touch the surfaces of Model X. Using any other type of car wash could cause damage that is not covered by the warranty.
-  **Caution:** Ensure the wipers are off before washing Model X to avoid the risk of damaging the wipers.
-  **Caution:** Do not use chemical based wheel cleaners. These can damage the finish on the wheels.
-  **Caution:** Avoid using a high pressure power washer on the camera(s) or parking sensors (if equipped) and do not clean a sensor or camera lens with a sharp or abrasive object that can scratch or damage its surface.
-  **Warning:** Never spray liquid at a high velocity (for example, if using a pressure washer) towards the charge port while Model X is charging. Failure to follow these instructions can result in serious injury or damage to the vehicle, charging equipment, or property.



Cleaning the Interior

Frequently inspect and clean the interior to maintain its appearance and to prevent premature wear. If possible, immediately wipe up spills and remove marks. For general cleaning, wipe interior surfaces using a soft cloth (such as microfiber) dampened with a mixture of warm water and mild non-detergent cleaner (test all cleaners on a concealed area before use). To avoid streaks, dry immediately with a soft lint-free cloth.

Interior Glass

Do not scrape, or use any abrasive cleaning fluid on glass or mirrored surfaces. This can damage the reflective surface of the mirror and the heating elements in the rear window.

Airbags

Do not allow any substance to enter an airbag cover. This could affect correct operation.

Dashboard and Plastic Surfaces

Do not polish the upper surfaces of the dashboard. Polished surfaces are reflective and could interfere with your driving view.

Leather Seats

Leather is prone to dye-transfer which can cause discoloration, particularly on light colored leather. White and tan leather is coated with an anti-soiling treatment. Wipe spills as soon as possible using a soft cloth moistened with warm water and non-detergent soap. Wipe gently in a circular motion. Then wipe dry using a soft, lint-free cloth. Using detergents or commercially available leather cleaners and conditioners is not recommended because they can discolor or dry out the leather.

Polyurethane Seats

Wipe spills as soon as possible using a soft cloth moistened with warm water and non-detergent soap. Wipe gently in a circular motion. After cleaning, allow the seats to air dry.

Cloth Seats

Wipe spills as soon as possible using a soft cloth moistened with warm water and non-detergent soap. Wipe gently in a circular motion. Then wipe dry using a soft, lint-free cloth. Vacuum the seats as needed to remove any loose dirt.

Carpets

Avoid over-wetting carpets. For heavily soiled areas, use a diluted upholstery cleaner.

Seat Belts

Extend the belts to wipe. Do not use any type of detergent or chemical cleaning agent. Allow the belts to dry naturally while extended, preferably away from direct sunlight.





Touchscreen and Instrument Panel

Clean the touchscreen and instrument panel using a soft lint-free cloth specifically designed to clean monitors and displays. Do not use cleaners (such as a glass cleaner) and do not use a wet wipe or a dry statically-charged cloth (such as a recently washed microfiber). To wipe the touchscreen without activating buttons and changing settings, you can enable clean mode. Touch **Controls** > **Displays** > **Clean Mode**. The display darkens to make it easy to see dust and smudges.

Chrome and Metal Surfaces

Polish, abrasive cleaners or hard cloths can damage the finish on chrome and metal surfaces.

Cautions for Interior Cleaning

-  **Caution:** Using solvents (including alcohol), bleach, citrus, naphtha, or silicone-based products or additives on interior components can cause damage.
-  **Caution:** Statically-charged materials can cause damage to the touchscreen or instrument panel.
-  **Warning:** If you notice any damage on an airbag or seat belt, contact Tesla immediately.
-  **Warning:** Do not allow any water, cleaners, or fabric to enter a seat belt mechanism.
-  **Warning:** Exposure to chemical cleaners can be hazardous and can irritate eyes and skin. Read and observe the instructions provided by the manufacturer of the chemical cleaner.



Polishing, Touch Up, and Body Repair

To preserve the cosmetic appearance of the body, you can occasionally treat the paint surfaces with an approved polish containing:

- Very mild abrasive to remove surface contamination without removing or damaging the paint.
- Filling compounds that fill scratches and reduce their visibility.
- Wax to provide a protective coating between the paint and environmental elements.

Regularly inspect the exterior paint for damage. Treat minor chips and scratches using a paint touch-up pen (available for purchase from Tesla). Use the touch-up pen after washing but before polishing or waxing.

Repair rock chips, fractures or scratches. Body repairs should be performed only by a Tesla approved body shop. Contact Tesla for a list of approved body shops.

⚠ Caution: Do not use cutting pastes, color restoration compounds, or polishes containing harsh abrasives. These can scour the surface and permanently damage the paint.

⚠ Caution: Do not use chrome polish or other abrasive cleaners.

Using a Car Cover

To preserve the cosmetic appearance of the body when Model X is not being used, use a genuine Tesla car cover. Car covers can be purchased from Tesla. See [Parts and Accessories](#) on page 173.

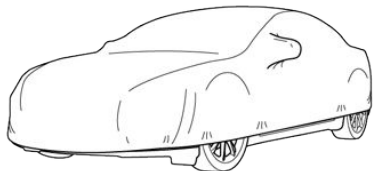

⚠ Caution: Use only a Tesla-approved car cover when Model X is plugged in. Using a non-Tesla car cover can prevent the Battery from being adequately cooled during charging.

Floor Mats

To extend the life of your carpet and make them easier to clean, use genuine Tesla floor mats (see [Parts and Accessories](#) on page 173). Maintain floor mats by regularly cleaning them and checking that they are properly attached. Replace floor mats if they become excessively worn.

⚠ Warning: To avoid potential interference with a foot pedal, ensure that the driver's floor mat is securely fastened, and never place an additional floor mat on top of it. Floor mats should always rest on top of the vehicle carpeting surface and not on another floor mat or other covering.



Checking and Replacing Wipers

To make wiper blades easy to access, turn off the wipers, shift Model X into Park, then use the touchscreen to move them to the service position. Touch **Controls** > **Settings** > **Service & Reset** > **Service Mode** > **ON**.

Note: Wipers automatically return to their normal position when you shift Model X out of Park.

Periodically check and clean the edge of the wiper blade and check the rubber for cracks, splits and roughness. If damaged, contact Tesla Service to have the blades replaced.

Contaminants on the windshield, or on the wiper blades, can reduce the effectiveness of the wiper blades. Contaminants include ice, wax spray from car washes, washer fluid with bug and/or water repellent, bird droppings, tree sap, and other organic substances.

Follow these guidelines for cleaning:

- Clean the windshield using non-abrasive glass cleaner.
- Lift the wiper arm a short distance away from the windshield, just far enough to access the wiper blade, then wipe the blade clean using isopropyl (rubbing) alcohol or washer fluid.

If the wipers remain ineffective after cleaning, the wipers may need to be replaced. The wiper washing system is an integrated part of the wiper blades and therefore it is not possible to replace just the wiper blades. For wiper replacement, contact Tesla Service.



Removing the Maintenance Panel

To check fluid levels, remove the maintenance panel:

1. Open the hood.
2. Pull the maintenance panel upward to release the clips that hold it in place.

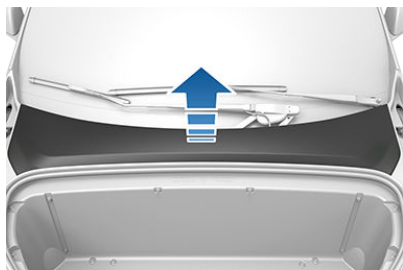

Caution: The maintenance panel protects the front trunk from water. When re-attaching, make sure it is fully seated.

Checking Battery Coolant

If the quantity of fluid in the cooling system drops below the recommended level, the instrument panel displays a warning message. Stop driving Model X as soon as safety permits and contact Tesla.

Fluid Level Check

Tesla checks the Battery coolant level at the regularly scheduled maintenance intervals.

DO NOT REMOVE THE FILLER CAP AND DO NOT ADD FLUID. Doing so can result in damage not covered by the warranty.

Do Not Top Up Battery Coolant

Warning: Battery coolant can be hazardous and can irritate eyes and skin. Under no circumstances should you remove the filler cap and/or add coolant. If the instrument panel warns you that the fluid level is low, contact Tesla immediately.

To maximize the performance and life of the Battery, the cooling system uses a specific mixture of G-48 ethylene-glycol coolant (HOAT). Contact Tesla for more specific information about the coolant.

Checking Brake Fluid

Warning: Contact Tesla immediately if you notice increased movement of the brake pedal or a significant loss of brake fluid. Driving under these conditions can result in extended stopping distances or complete brake failure.



The Brake indicator on the instrument panel alerts you if the quantity of fluid in the brake reservoir drops below the recommended level. If it displays while driving, stop as soon as safety permits by gently applying the brakes. Do not continue driving. Contact Tesla immediately.

Fluid Level Check

Tesla checks the brake fluid level at the regularly scheduled maintenance intervals.

Topping Up the Brake Fluid

Do not top up your brake fluid. Tesla service does this when you bring Model X in for regular servicing. The following instructions are provided for information purposes and future reference only:

1. Clean the filler cap before removing it to prevent dirt from entering the reservoir.
2. Unscrew the cap and remove it.
3. Top up the reservoir to the MAX mark using the appropriate brake fluid.
4. Replace the filler cap, ensuring it is fully secured.

Warning: Only use new fluid from a sealed air-tight container. Never use previously used fluid or fluid from a previously opened container—fluid absorbs moisture which decreases braking performance.

Warning: Brake fluid is highly toxic. Keep containers sealed and out of the reach of children. In the event of accidental consumption, seek medical attention immediately.

Caution: Brake fluid damages painted surfaces. Immediately soak up any spills with an absorbent cloth and wash the area with a mixture of car shampoo and water.



Topping Up Washer Fluid

The only reservoir into which you can add fluid is the washer fluid reservoir, which is located behind the front trunk. When the level is low, a message displays on the instrument panel.

⚠ Caution: Do not add formulated washer fluids that contain water repellent or bug wash. These fluids can cause streaking, smearing, and squeaking or other noises.

Operate the washers periodically to check that the nozzles are clear and properly directed. See [Wipers and Washers](#) on page 61.

To top up the washer fluid:

1. Open the hood.
2. Clean around the filler cap before opening it to prevent dirt from entering the reservoir.
3. Open the filler cap.

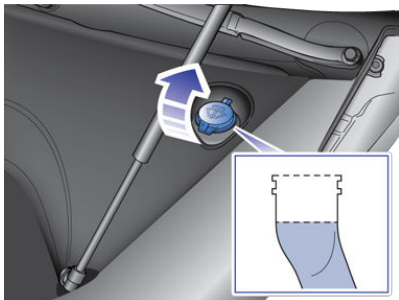

4. Fill the reservoir until the fluid level is visible just below the filler neck.
5. Replace the filler cap.

Note: Some national or local regulations restrict the use of Volatile Organic Compounds (VOCs). VOCs are commonly used as antifreeze in washer fluid. Use a washer fluid with limited VOC content only if it provides adequate freeze resistance for all climates in which you drive Model X.

⚠ Caution: Under no circumstances do you need to inspect or top up other fluid reservoirs. Two additional fluid reservoirs are located next to the washer fluid, but underneath the maintenance panel. In the unlikely event that you see a message on the instrument panel that one of these fluid levels is low, stop driving Model X as soon as safe to do so, and contact Tesla.

⚠ Caution: Do not spill washer fluid on body panels. Doing so can cause damage.

Wipe up spills immediately and wash the affected area with water.

⚠ Warning: In temperatures below 40° F (4° C), use a washer fluid with antifreeze. In cold weather, using a washer fluid without antifreeze can impair visibility through the windshield.

⚠ Warning: Windshield washer fluid can irritate eyes and skin. Read and observe the instructions provided by the washer fluid manufacturer.



Jacking Procedure

Follow the steps below to lift Model X. Ensure that any non-Tesla repair facility is aware of these lifting points.

1. Position Model X centrally between the lift posts.
2. If your Model X is equipped with Smart Air Suspension, it automatically self-levels, even when power is off. Use the touchscreen to set the suspension as follows:
 - Touch **Controls > Suspension**.
 - Press the brake pedal, then touch **Very High** to maximize the height of the suspension.
 - Touch **Jack** to disable self-leveling.
3. Close the falcon wing doors.
4. Position the lift arm pads under the designated body lift points at the locations shown.

Warning: DO NOT position the lift arm pads under the Battery.

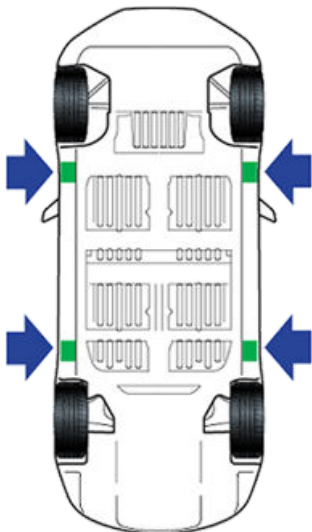

5. Adjust the height and position of the lift arm pads to ensure that they are correctly located.
6. With assistance, raise the lift, ensuring the lift arm pads remain in their correct positions.

Note: Jack mode cancels when Model X is driven over 4 mph (7 km/h).

Note: Jack mode may be unexpectedly enabled in situations where an object is supporting the vehicle's weight (for example the bumper of the vehicle is resting on a curb).

Warning: If your Model X is equipped with Smart Air Suspension, it automatically self-levels, even when power is off. You **MUST** disable this system by engaging Jack mode before lifting or jacking. If you do not disable Smart Air Suspension, Model X can attempt to self-level, causing serious damage, bodily injury, or death.

Warning: Never raise Model X when the charge cable is connected, even if charging is not in progress.

Warning: Do not work on an incorrectly supported vehicle. Doing so can cause serious damage, bodily injury, or death.

Caution: DO NOT lift from under the Battery. Place the lift arm pads under the designated body lift points only. The locations shown are the only approved lifting points for Model X. Lifting at any other points can cause damage. Damage caused by incorrectly lifting Model X is not covered by the warranty.

Parts, Accessories, and Modifications

Use only genuine Tesla parts and accessories. Tesla performs rigorous testing on parts to ensure their suitability, safety, and reliability. Purchase these parts from Tesla, where they are professionally installed and where you can receive expert advice about modifications to Model X. Accessories are available for purchase from Tesla stores or online at www.tesla.com/shop.

Tesla is unable to assess parts manufactured by other distributors and therefore accepts no responsibility if you use non-Tesla parts on Model X.

- ⚠ Warning:** Installing non-approved parts and accessories, or performing non-approved modifications, can affect the performance of Model X and the safety of its occupants. Any damage caused by using or installing non-approved parts, or by performing non-approved modifications, is not covered by the warranty.
- ⚠ Warning:** Tesla does not accept liability for death, personal injury or damage that occurs if you use or install non-approved accessories or make non-approved modifications.

Body Repairs

If Model X is in a collision, contact Tesla to ensure that it is repaired with genuine Tesla parts. Tesla has selected and approved body shops that meet strict requirements for training, equipment, quality, and customer satisfaction.

Some repair shops and insurance companies might suggest using non-original equipment or salvaged parts to save money. However, these parts do not meet Tesla's high standards for quality, fit and corrosion resistance. In addition, non-original equipment and salvaged parts (and any damage or failures they might cause) are not covered by the warranty.

Using RFID Transponders

When attaching an RFID transponder (used by many automated toll systems) inside Model X, place the transponder in the topmost area of the windshield as shown. This ensures best results and minimizes any obstruction to your driving view.

Note: You can also attach a weather-proof transponder to the front license plate.

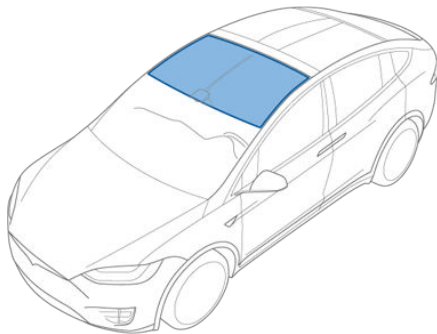



Vehicle Identification Number

You can find the VIN at the following locations:

- Touch the Tesla “T” at the top center of the touchscreen. The popup window displays the VIN.
- Stamped on a plate located at the top of the dashboard. Can be seen by looking through the windshield.
- Printed on the Vehicle Certification label, located on the door pillar. Can be seen when the driver’s door is open.

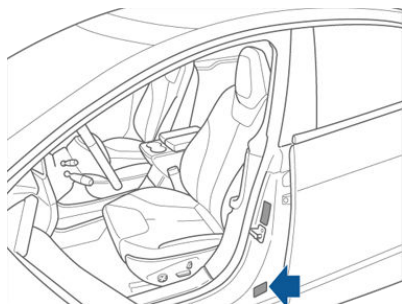

- Stamped on the chassis under the sill panel on the rear passenger door. To remove the sill panel, gently pry it upward using a flat-bladed tool.

Note: The VIN was not stamped on the chassis on vehicles manufactured between approximately June 2, 2016 and Feb 28, 2017.

⚠ Caution: Removing the sill panel to view the VIN is not recommended because damage is likely to occur. The panel is held in place with fragile clips that break easily. Damage caused by removing the sill panel is not covered by the warranty.

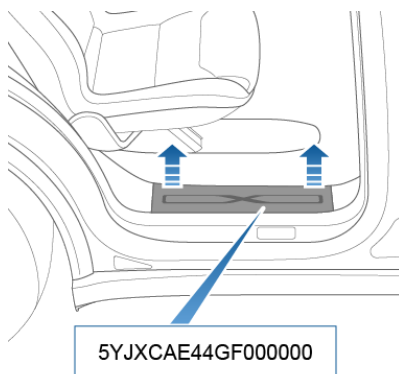

Emission Control Label

The emission control label is located on the opening face of the liftgate.





Load Capacity Labeling

It is important to understand how much weight your Model X can safely carry. This weight is called the vehicle capacity weight and includes the weight of all occupants, cargo and any additional equipment added to your Model X since it was manufactured.

One or more labels attached to the center door pillar indicate how much weight Model X can safely carry. Labels are visible when the front door is open.

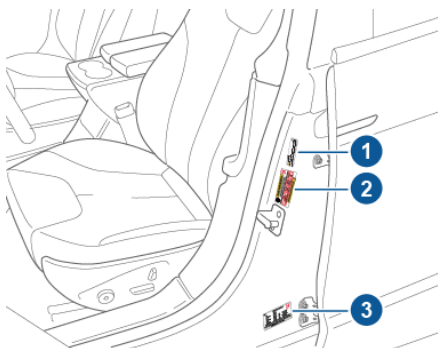

1. Towing label (if equipped)
2. Tire and Loading Information label
3. Vehicle Certification label

Note: Towing capability is available only if Model X is equipped with the Towing Package.

Warning: Overloading Model X has an adverse effect on braking and handling, which can compromise your safety or cause damage.

Caution: Never load more than 175 lbs (80 kg) on the rear load floor (above the lower trunk compartment) or more than 130 lbs (60 kg) in the lower trunk compartment. Doing so can cause damage.

Caution: Never store large amounts of liquid in Model X. A significant spill can cause electrical components to malfunction.

Towing Label

If equipped with the towing package, the Towing Label instructs you to refer to this owner's manual for tire pressures that should be used when towing a trailer. Do not use the tire pressures printed on the Tire and Loading Information Label.

IMPORTANT!

For towing and high speed driving, please refer to owner's manual for tire inflation pressure requirements.

Note: Towing capability is available only if Model X is equipped with the Towing Package. Tire pressure information, along with other information related to towing, is located in the topic "Towing a Trailer" in the Driving section of the onscreen owners manual.

Tire and Loading Information Label

The Tire and Loading Information label provides:

- The maximum number of occupant seating positions.
- The maximum vehicle capacity weight.
- The size of the original tires.
- The cold inflation pressures for the original front and rear tires. These pressures are recommended to optimize ride and handling characteristics.

U.S. and Canada:

TIRE AND LOADING INFORMATION
RENSEIGNEMENTS SUR LES PNEUS ET LE CHARGEMENT

SEATING CAPACITY/NOMBRE DE PLACES - TOTAL X FRONT/AVANT X REAR/ARRIERE X
LE POIDS TOTAL DES OCCUPANTS ET DU CHARGEMENT NE DOIT JAMAIS DEPASSER

THE COMBINED WEIGHT OF OCCUPANTS AND CARGO SHOULD NEVER EXCEED
LE POIDS TOTAL DES OCCUPANTS ET DU CHARGEMENT NE DOIT JAMAIS DEPASSER

TIRE/PNEU	FRONT/AVANT	REAR/ARRIERE	SPARE/DE SECOURS
ORIGINAL TIRE SIZE/ TAILLE DES PNEUS D'ORIGINE	depends on vehicle model	depends on vehicle model	NONE/AUCUN
COLD TIRE PRESSURE/ PRESSION DES PNEUS A FROID	depends on vehicle model	depends on vehicle model	NONE/AUCUN

SEE OWNER'S MANUAL FOR ADDITIONAL INFORMATION. VOIR LE MANUEL DE L'USAGER POUR PLUS DE RENSEIGNEMENTS.

Mexico:

INFORMACIÓN DE NEUMÁTICOS Y DE CARGA

NÚMERO TOTAL DE PLAZAS - ADELANTE 2 ATRÁS
EL PESO COMBINADO DE LOS OCUPANTES Y LA CARGA NUNCA DEBE EXCEDER

NEUMÁTICO	DELANTERO	TRASERO	REFACCIÓN
TAMAÑO DE NEUMÁTICO ORIGINAL			N/A
PRESIÓN DE INFLADO PARA LLANTAS EN FRO			N/A

CONSULTE EL MANUAL DEL PROPIETARIO PARA MÁS INFORMACIÓN

Never change this label, even if you use different tires in the future.

Note: If Model X is loaded to its full capacity, double check all tires to ensure they are inflated to their recommended pressure levels.

Warning: Tire pressures printed on the Tire and Loading Information label DO NOT APPLY to towing. When towing, tire pressures must be increased. For information about the tire pressures required when towing, see [Towing and Accessories](#) on page 75.



Vehicle Certification Label

The Vehicle Certification label provides:

- GVWR - Gross Vehicle Weight Rating. The maximum allowable total mass of Model X. This is calculated as the weight of Model X, all passengers, fluids, and cargo.
- GAWR FRT and GAWR RR - Gross Axle Weight Rating for the front and rear axles. The GAWR is the maximum distributed weight that each axle can support.

United States:

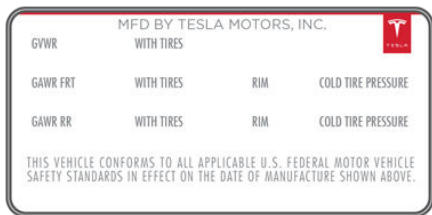

Canada:



Mexico:



- ⚠ **Caution:** To prevent damage, never load Model X so that it is heavier than GVWR or exceeds the individual GAWR weights.

Calculating Load Limits

1. Locate the statement “The combined weight of occupants and cargo should never exceed XXX kg or XXX lbs” on the “Tire and Loading Information” label.

2. Determine the combined weight of all occupants that will ride in the vehicle.
3. Subtract the combined weight of the occupants from XXX kg or XXX lbs (see Step 1).
4. The resulting figure equals the available cargo load capacity. For example, if the “XXX” amount equals 1400 lbs (635 kg) and there will be five 150 lb (68 kg) passengers in the vehicle, the amount of available cargo capacity is 650 lbs (1400 - 750 (5 x 150) = 650 lbs) or 295 kg (635 - 340 (5 x 68) = 295 kg).
5. Determine the combined cargo weight being loaded on the vehicle. That weight must not exceed the available cargo load capacity calculated in Step 4.

- ⚠ **Warning:** Trunks are the preferred places to carry objects. In a collision, or during hard braking and sharp turns, loose items in the cabin could injure occupants.

Example Load Limit Calculations

How much cargo Model X can carry depends on the number and weight of passengers. The following calculated load limit examples assume passengers weigh 150 lbs (68 kg). If passengers weigh more or less, available cargo weight decreases or increases respectively.

Driver and one passenger

Description	Total
Vehicle capacity weight	954 lbs (433 kg)
Subtract occupant weight (2 x 150 lbs/68 kg)	300 lbs (136 kg)
Available cargo weight	654 lbs (297 kg)

Driver and four passengers

Description	Total
Vehicle capacity weight	954 lbs (433 kg)
Subtract occupant weight (5 x 150 lbs/68 kg)	750 lbs (340 kg)
Available cargo weight	204 lbs (93 kg)



The cargo weight should be distributed between the front and rear trunks.

 **Caution:** Never load more than 175 lbs (80 kg) on the rear load floor (above the lower trunk compartment) or more than 130 lbs (60 kg) in the lower trunk compartment. Doing so can cause damage.



Exterior Dimensions

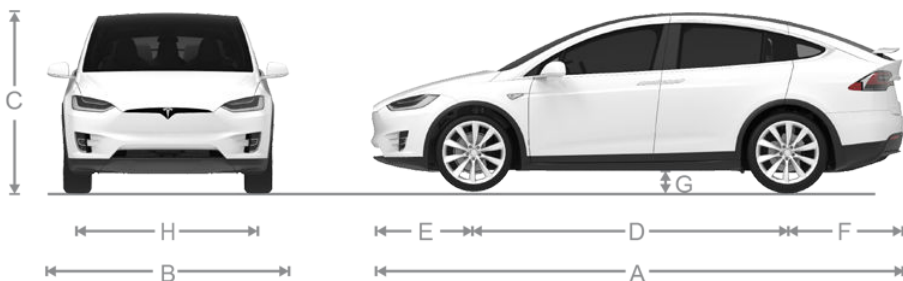

A	Overall Length	199 in	5,052 mm
B	Overall Width (including mirrors)	89 in	2,272 mm
	Overall Width (including folded mirrors)	82 in	2,017 mm
	Overall Width (excluding mirrors)	79 in	1,999 mm
C	Overall Height	66 in*	1,684 mm*
D	Wheel Base	117 in	2,965 mm
E	Overhang - Front	39 in	989 mm
F	Overhang - Rear	43 in	1,098 mm
G	Ground Clearance: Standard, with skis	7 in	171 mm
	Standard, without skis	7 in	183 mm
	Very high, with skis	8 in	211 mm
	Very high, without skis	9 in	223 mm
H	Track - Front	67 in	1,711 mm
	Track - Rear	67 in	1,723 mm

*Values are approximate. The dimensions can vary depending on vehicle configuration and various other factors.

Interior Dimensions

Head Room	Front	41.7 in	1059 mm
	Rear	40.9 in	1039 mm
	Third	37.1 in	942 mm
Leg Room	Front	41.2 in	1046 mm
	Rear	38.4 in	975 mm
	Third	32.7 in	831 mm
Shoulder Room	Front	60.7 in	1542 mm
	Rear	56.8 in	1442 mm
	Third	40 in	1016 mm



Hip Room	Front Rear Third	55.6 in 59 in 38.5 in	1412 mm 1498 mm 978 mm
----------	------------------------	-----------------------------	------------------------------

Cargo Volume

	Front Trunk	Rear*	Total
Seven Seat Vehicles	6.6 cu ft (187 L)	76.5 cu ft (2166 L)**	83.1 cu ft (2353 L)
Six Seat Vehicles	6.6 cu ft (187 L)	70.7 cu ft (2002 L)**	77.3 cu ft (2189 L)
Five Seat Vehicles	6.6 cu ft (187 L)	81.2 cu ft (2299.5 L)**	87.8 cu ft (2486.5 L)
* Maximum cargo volume behind the front row seats. Includes the 12.6 cu ft (357 L) cargo area in the rear trunk (area behind the third row seats, if equipped).			
** Second row seats fully forward and/or folded.			

Weights

Curb Weight* - 60D/75D	5,185 lbs	2,352 kg
Curb Weight* - 90D	5,267 lbs	2,389 kg
Curb Weight* - P90D	5,377 lbs	2,439 kg
Curb Weight* - 100D	5,421 lbs	2,459 kg
Curb Weight* - P100D	5,483 lbs	2,487 kg
GVWR** - 60D/75D	6,581 lbs	2,985 kg
GVWR** - 90D	6,658 lbs	3,020 kg
GVWR** - P90D	6,768 lbs	3,070 kg
GVWR** - 100D	6,788 lbs	3,079 kg
GVWR** - P100D	6,878 lbs	3,120 kg
Gross Vehicle Weight Distribution - 60D/75D	Front: 2,890 lbs Rear: 3,690 lbs	Front: 1,311 kg Rear: 1,674 kg
Gross Vehicle Weight Distribution - 90D	Front: 2,977 lbs Rear: 3,681 lbs	Front: 1,350 kg Rear: 1,670 kg
Gross Vehicle Weight Distribution - P90D	Front: 2,976 lbs Rear: 3,792 lbs	Front: 1,350 kg Rear: 1,720 kg
Gross Vehicle Weight Distribution - 100D	Front: 3,097 lbs Rear: 3,690 lbs	Front: 1,405 kg Rear: 1,674 kg
Gross Vehicle Weight Distribution - P100D	Front: 3,027 lbs Rear: 3,851 lbs	Front: 1,373 kg Rear: 1,747 kg



Dimensions and Weights

Gross Axle Weight Rating- Front	3,241 lbs	1,470 kg
Gross Axle Weight Rating - Rear (at nominal tire pressure of 42 psi)	3,968 lbs	1,800 kg
Towing Capacity (if equipped)	See Towing and Accessories on page 75.	
*Curb Weight = weight of the vehicle with correct fluid levels, no occupants and no cargo		
**GVWR = Gross Vehicle Weight Rating		



Motor

Type	AC induction motor, liquid-cooled, with variable frequency drive
Nominal Voltage	320 volts
Maximum speed of large motors (rear motor on Performance vehicles)	18700 rpm
Maximum speed of small motors (front motor on all vehicles, rear motor on non-Performance vehicles)	18200 rpm
Maximum net power* and motor speed of large motors	375 kW @ 6,150 rpm
Maximum net power* and motor speed of small motors	193 kW @ 6,100-6,800 rpm
Maximum torque of large motors	660 Nm
Maximum torque of small motors	330 Nm
*Tested in accordance with ECE R85	

Transmission

Type	Single speed fixed gear
Overall Final Drive Ratio	Small motor: 9.325:1 Large motor: 9.734:1
Reverse Gear	Reverse direction of motor, limited to 15 mph (24 km/h)

Steering

Type	Rack and pinion with electronic power steering, speed sensitive
Number of turns lock to lock	2.05
Turning Circle (curb to curb)	38.8 ft (11.8 m)

Brakes

Type	4-wheel anti-lock braking system (ABS) with Electronic Brake Force Distribution, Integrated Advanced Stability Control and Electronic Accelerator pedal actuated regenerative braking system
Calipers	Four piston fixed
Rotor Diameters (ventilated)	Front: 13.98"/355 mm Rear: 14.37"/365 mm



Front Rotor thickness	New: 1.26"/32 mm Service limit: 1.18"/30 mm
Rear Rotor thickness	New: 1.10"/28 mm Service limit: 1.02"/26 mm
Front Brake Pad Thickness (excluding back plate)	0.393"/10 mm
Rear Brake Pad Thickness (excluding back plate)	Base: 0.354"/9 mm
Parking brake	Electrically actuated parking brake calipers

Suspension

Front	Independent, virtual pivot double wishbone
Rear	Independent, virtual pivot double wishbone

Battery - 12V

Rating	33 amp hour or higher
Voltage and Polarity	12V negative (-) ground

Battery - High Voltage

Type	Liquid-cooled lithium ion (Li-ion)
Rating	60, 70, 75, 85, 90, or 100 kWh (at beginning of life)
Nominal Voltage - 85, 90, and 100 kWh Nominal Voltage - 60, 70, and 75 kWh	350 V DC 300 V DC
Temperature Range	Do not expose Model X to ambient temperatures above 140° F (60° C) or below -22° F (-30° C) for more than 24 hours at a time.



Wheel Specifications

Wheel Type	Size	Offset
20" - All Season - Front	9.0J x 20	1.378" 35 mm
20" - All Season - Rear	9.5J x 20	1.575" 40 mm
20" - Summer - Front	9.0J x 20	1.378" 35 mm
20" - Summer - Rear	10.0J x 20	1.378" 35 mm
22" - Summer - Front	9.0J x 22	1.378" 35 mm
22" - Summer - Rear	10.0J x 22	1.378" 35 mm

Lug Nut Torque	129 lb. ft (175 Nm)
Lug Nut Socket Size	21 mm
Note: For instructions on how to jack/lift Model X, see Jacking and Lifting on page 172.	

Tire Specifications

Tire Type	Size	Load Index / Speed Rating
20" - Continental - Front	265/45R20	108 / V
20" - Continental - Rear	275/45R20	110 / V
20" - Michelin - Front	255/45R20	105 / Y
20" - Michelin - Rear	275/45R20	110 / Y
22" - Goodyear or Pirelli - Front	265/35R22	102 / W
22" - Goodyear or Pirelli - Rear	285/35R22	106 / W

Refer to the tire pressures printed on the Tire and Loading Information label. This label is located on the driver's door pillar and is visible when the driver's door is open (see [Maintaining Tire Pressures](#) on page 160).

Winter tires can be purchased from a Tesla store.



Understanding Tire Markings

Laws require tire manufacturers to place standardized information on the sidewall of all tires. This information identifies and describes the fundamental characteristics of the tire. It also provides the tire identification number (TIN) for certification of safety standards, and in case of a recall.



1	Tire category. P indicates that the tire is for passenger vehicles.
2	Tire width. This 3-digit number is the width (in millimeters) of the tire from sidewall edge to sidewall edge.
3	Aspect ratio. This 2-digit number is the sidewall height as a percentage of the tread width. So, if the tread width is 205 mm, and the aspect ratio is 50, the sidewall height is 102 mm.
4	Tire construction. R indicates that the tire is of Radial ply construction.
5	Wheel diameter. This 2-digit number is the diameter of the wheel rim in inches.
6	Load index. This 2 or 3-digit number is the weight each tire can support. This number is not always shown.
7	Speed rating. When stated, indicates the maximum speed (in mph) at which the tire can be used for extended periods. Q=99 mph (160 km/h), R=106 mph (170 km/h), S=112 mph (180 km/h), T=118 mph (190 km/h), U=124 mph (200 km/h), H=130 mph (210 km/h), V=149 mph (240 km/h), W=168 mph (270 km/h), Y=186 mph (300 km/h).
8	Tire composition and materials. The number of plies in both the tread area and the sidewall area indicates how many layers of rubber coated material make up the structure of the tire. Information is also provided on the type of materials used.
9	Maximum tire load. The maximum load which can be carried by the tire.



10	Maximum permissible inflation pressure. This pressure should not be used for normal driving.
11	U.S. DOT Tire Identification Number (TIN). Begins with the letters DOT and indicates that the tire meets all federal standards. The next 2 digits/letters represent the plant code where it was manufactured, and the last 4 digits represent the week and year of manufacture. For example, the number 1712 is used to represent the 17th week of 2012. The other numbers are marketing codes used at the manufacturer's discretion. This information can be used to contact consumers if a tire defect requires a recall.
12	Treadwear grade. This number indicates the tire's wear rate. The higher the treadwear number is, the longer it should take for the tread to wear down. A tire rated at 400, for example, lasts twice as long as a tire rated at 200.
13	Traction grade. Indicates a tire's ability to stop on wet roads. A higher graded tire should allow you to stop your vehicle in a shorter distance than a tire with a lower grade. Traction is graded from highest to lowest as AA, A, B, and C.
14	Temperature grade. The tire's resistance to heat is grade A, B, or C, with A indicating the greatest resistance. This grading is provided for a correctly inflated tire, which is being used within its speed and loading limits.



Uniform Tire Quality Grading

The following information relates to the tire grading system developed by the National Highway Traffic Safety Administration (NHTSA), which grades tires by tread wear, traction and temperature performance. Tires that have deep tread, and winter tires, are exempt from these marking requirements.

Where applicable, quality grades are found on the tire's sidewall between the tread shoulder and maximum section width. For example:

- TREADWEAR 180
- TRACTION AA
- TEMPERATURE A

The quality grades are described next.

Note: In addition to the marking requirements, passenger car tires must conform to Federal Safety Requirements.

Treadwear

The treadwear grade is a comparative rating based on the wear rate of the tire when tested under controlled conditions on a specified government test course.

For example, a tire graded 150 wears one and a half times better on a government test course than a tire graded 100. The relative performance of tires depends on the actual conditions of their use, however, and can depart significantly from the norm due to variations in driving habits, service practices, road characteristics, and climate.

Traction

The traction grades, from highest to lowest, are: AA, A, B, and C. These grades represent a tire's ability to stop on wet pavement as measured under controlled conditions on test surfaces of asphalt and concrete. A tire marked C might have poor traction performance.

Warning: Defective tires are dangerous. Do not drive if a tire is damaged, excessively worn, or is inflated to an incorrect pressure. The safety of the vehicle and occupants can be adversely affected. Check tires regularly for wear and to ensure there are no cuts, bulges or exposure of the ply/cord structure.

Warning: The traction grade assigned to the tire is based on straight-ahead braking tests, and does not include:

acceleration, cornering, hydroplaning or peak traction characteristics.

Temperature

The temperature grades are A (the highest), B, and C, representing the tire's resistance to the generation of heat and its ability to dissipate heat when tested under controlled conditions on a specified indoor laboratory test wheel. Sustained high temperature can cause the tire to degenerate and reduce tire life, and excessive temperature can lead to sudden tire failure.

The grade C corresponds to the minimum level of performance that all passenger car tires must meet under the Federal Motor Safety Standard No. 109. Grades B and A represent levels of performance on the laboratory test wheel that exceed the minimum requirements.

Warning: A tire's temperature grade is established for a tire that is properly inflated and not overloaded. Excessive speed, under-inflation, or excessive loading, either separately or in combination, can cause heat buildup and possible tire failure.



Tire and Loading Glossaries

General Wheel and Tire Terms

Accessory Weight	The combined weight (in excess of those items replaced) of items available as factory installed equipment.
Bead	The inner edge of a tire that is shaped to fit to the rim and form an air tight seal. The bead is constructed of steel wires which are wrapped, or reinforced, by the ply cords.
Cold Tire Pressure	The air pressure in a tire that has been standing in excess of three hours, or driven for less than one mile.
Curb Weight	The weight of a standard vehicle, including any optional equipment fitted, and with the correct fluid levels.
Gross Vehicle Weight	The maximum permissible weight of a vehicle with driver, passengers, load, luggage, and equipment.
kPa (kilo pascal)	A metric unit used to measure pressure. One kilo pascal equals approximately 0.145 psi.
Maximum Inflation Pressure	The maximum pressure to which the tire should be inflated. This pressure is given on the tire side wall in psi (lbf/in ²). ⚠ Caution: This pressure marked on the tire is the maximum allowed by the tire manufacturer. It is not the pressure Tesla recommends using for Model X.
Maximum Loaded Vehicle Weight	The sum of curb weight, accessory weight, vehicle capacity weight, and production options weight.
Production Options Weight	The combined weight of options installed which weigh in excess of 3 lb more than the standard items that they replaced, and are not already considered in curb or accessory weights.
PSI (lbf/in ²)	Pounds per square inch (the unit used to measure tire pressure).
Recommended Tire Inflation Pressure	Tire inflation pressure, established by Tesla, which is based on the type of tires that are mounted on the vehicle at the factory. This information can be found on the Tire and Loading Information label located on the door pillar.
Rim	The metal support for a tire, or tire and tube, upon which the tire beads are seated.
Vehicle Capacity Weight	The number of seats multiplied by 150 lbs plus the rated amount of load/luggage.

Load Carrying Definitions

Normal occupant weight	68 kilograms (150 lbs) times the number of occupants specified in the second column of the tables for calculating load limits (see Vehicle Loading on page 175).
Occupant distribution	Distribution of occupants in a vehicle.
Passenger car tire	A tire intended for use on passenger cars, multipurpose passenger vehicles, and trucks, that have a gross vehicle weight rating (GVWR) of 10,000 pounds or less.



Rim diameter	Nominal diameter of the bead seat.
Rim size designation	Rim diameter and width.
Rim type designation	The manufacturing industry's designation for a rim by style or code.
Rim width	Nominal distance between the rim's flanges.
Vehicle maximum load on the tire	Load on an individual tire that is determined by distributing to each axle its share of the maximum loaded vehicle weight and dividing by two.
Vehicle normal load on the tire	Load on an individual tire that is determined by distributing to each axle its share of the curb weight, accessory weight, and normal occupant weight and dividing by two.

Pneumatic Radial Tire Definitions

Bead separation	A breakdown of the bond between components in the bead.
Bias ply tire	A pneumatic tire in which the ply cords that extend to the beads are laid at alternate angles substantially less than 90 degrees to the center line of the tread.
Carcass	The tire structure, except tread and sidewall rubber which, that when inflated, bears the load.
Chunking	The breaking away of pieces of the tread or sidewall.
Cord	The strands forming the plies in the tire.
Cord separation	The parting of cords from adjacent rubber compounds.
Cracking	Any parting within the tread, sidewall, or inner liner of the tire extending to cord material.
Extra load tire	A tire designed to operate at higher loads and higher inflation pressure than the corresponding standard tire.
Groove	The space between two adjacent tread ribs.
Inner liner	The layer(s) forming the inside surface of a tubeless tire that contains the inflating medium within the tire.
Inner liner separation	The parting of the inner liner from cord material in the carcass.
Load rating	The maximum load that a tire is rated to carry for a given inflation pressure.
Maximum load rating	The load rating for a tire at the maximum permissible inflation pressure for that tire.
Measuring rim	The rim on which a tire is fitted for physical dimension requirements.
Open splice	Any parting at any junction of tread, sidewall, or inner liner that extends to the cord material.
Outer diameter	The overall diameter of an inflated new tire.



Overall width	The linear distance between the exteriors of the sidewalls of an inflated tire, including elevations due to labeling, decorations, or protective bands or ribs.
Ply	A layer of rubber-coated parallel cords.
Ply separation	A parting of rubber compound between adjacent plies.
Pneumatic tire	A mechanical device made of rubber, chemicals, fabric and steel or other materials, that, when mounted on an automotive wheel, provides the traction and contains the gas or fluid that sustains the load.
Radial ply tire	A pneumatic tire in which the ply cords that extend to the beads are laid at substantially 90 degrees to the center line of the tread.
Reinforced tire	A tire designed to operate at higher loads and at higher inflation pressures than the corresponding standard tire.
Section width	The linear distance between the exteriors of the sidewalls of an inflated tire, excluding elevations due to labeling, decoration, or protective bands.
Sidewall	The portion of a tire between the tread and bead.
Sidewall separation	The parting of the rubber compound from the cord material in the sidewall.
Snow tire	A tire that attains a traction index equal to or greater than 110, compared to the ASTM E1136-93 (re-approved 2003, incorporated by reference, see §571.5) Standard Reference Test Tire when using the snow traction test as described in ASTM F1805-00 (incorporated by reference, see §571.5), and that is marked with an Alpine Symbol specified in S5.5(i) on at least one sidewall.
Test rim	The rim on which a tire is fitted for testing, and may be any rim listed as appropriate for use with that tire.
Tread	The portion of a tire that comes into contact with the road.
Tread rib	A tread section running around the circumference of a tire.
Tread separation	The pulling away of the tread from the tire carcass.
Tread wear indicators (TWI)	The projections within the principal grooves designed to give a visual indication of the degrees of wear of the tread.
Wheel-holding fixture	The fixture used to hold the wheel and tire assembly securely during testing.



Contacting Roadside Assistance

Tesla Roadside Assistance is available to you, 24 hours a day, 365 days a year, for the duration of your warranty period.

When contacting Tesla Roadside Assistance, please provide:

- The Vehicle Identification Number (VIN). The VIN is displayed when you touch the Tesla "T" at the top of the touchscreen. The VIN can also be seen on the upper dashboard by looking through the driver's side of the windshield.
- Your exact location.
- The nature of the problem.

Tesla Roadside Assistance is available to speak with roadside service professionals 24/7/365 to answer any questions and explain the proper procedure for transporting your Model X.

Regional Phone Number(s)

Mexico: [1-800-228-8145](tel:1-800-228-8145)

United States and Canada: [1-877-79TESLA](tel:1-877-79TESLA) ([1-877-798-3752](tel:1-877-798-3752))

Note: The phone number is also available by touching the Tesla "T" at the top center of the touchscreen.



When Transporting Model X

Always transport Model X with all four tires off the ground. A flatbed truck or comparable transport vehicle is recommended. A wheel lift and dolly can be used only when transporting Model X for a maximum of 15 miles (25 km), provided the driving speed does not exceed 45 mph (70 km/h). When transporting, whether on a flatbed truck or using a wheel lift and dolly, Model X can face either direction.

Do not transport Model X using any other method unless specified by Tesla. Follow the steps provided and observe all warnings and cautions. Damage caused by transporting your vehicle is not covered by the warranty.

Note: The following illustrations are for demonstration purposes only.



Warning: Model X is equipped with high voltage components (see [High Voltage Components](#) on page 150). Before transporting Model X as a result of an event (such as a collision) that may have compromised a high voltage component, it is important to assume that these components are energized. Always follow high voltage safety precautions (wearing personal protective equipment, etc.) until emergency response professionals have evaluated the vehicle and can accurately confirm that all high voltage systems are no longer energized. Failure to do so may result in serious injury or death.

Disable Self-Leveling (air suspension vehicles only)

If Model X is equipped with Smart Air Suspension, it automatically self-levels, even when power is off. To prevent damage, you must activate Jack mode to disable self-leveling:

1. Touch **Controls** > **Suspension** on the touchscreen.
2. Press the brake pedal, then touch **Very High** to maximize height.

3. Touch **Jack**.

Note: Jack mode cancels when Model X is driven over 4 mph (7 km/h).

Warning: Failure to activate Jack mode on a Model X equipped with Smart Air Suspension can result in the vehicle becoming loose during transport, which may cause significant damage.

Activate Tow Mode

Model X may automatically shift into Park when it detects the driver leaving the vehicle, even if it has previously been shifted into Neutral. To keep Model X in Neutral (which disengages the parking brake), you must use the touchscreen to activate Tow mode:

1. Shift into Park.
2. Chock the tires or otherwise ensure Model X is stable.
3. Press and hold the brake pedal, then on the touchscreen touch **Controls** > **Settings** > **Service & Reset** > **Tow Mode** > **ON**.



When Tow mode is active, Model X displays this indicator light on the instrument panel, along with a message telling you that Model X is free-rolling.

To cancel Tow Mode, shift Model X into Park.

Caution: If the electrical system is not working, and you therefore cannot release the electric parking brake, attempt to jump start the 12V battery. For instructions, call Tesla Roadside Assistance. If a situation occurs where you cannot disengage the parking brake, use a self-loading dolly or tire skates. Before doing so, always check the manufacturer's specifications and recommended load capacity.

Pull onto the Flatbed Truck

The method used to pull Model X onto the truck depends on whether a tow eye is available (provided with your vehicle at time of purchase).

If equipped with a tow eye:

1. Locate the tow eye.



2. Remove the tow eye cover by inserting a small flat screwdriver into the slot located along the top of the cover, then prying gently to release the cover from the top snap.

⚠ Caution: Keep the tow eye cover in a safe place so you can replace it when towing is complete.

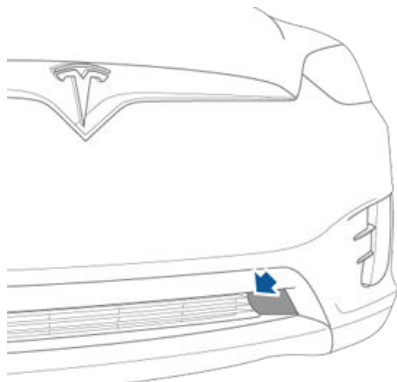

3. Fully insert the tow eye into the opening, then turn it **counter-clockwise** until securely fastened.

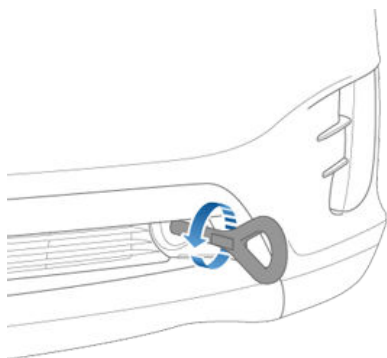

4. Attach the winch cable to the tow eye.
- ⚠ Caution:** Before pulling, make sure the tow eye is securely tightened.
5. Pull Model X slowly onto the flatbed truck.
 6. Shift Model X into Park by pressing the button on the end of the gear selector.

If not equipped with a tow eye:

1. Attach the tow straps to the large hole on each of the rearmost lower suspension arms underneath the front of the vehicle.

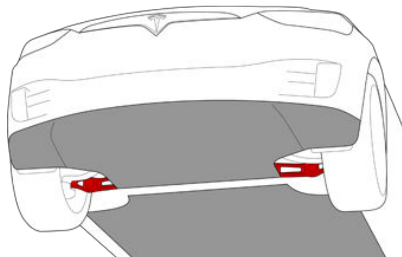

2. To protect the underbody from any damage, place a protective barrier (such as a piece of wood) between the tow strap and the underbody.
3. Pull Model X slowly onto the flatbed truck.
4. Shift Model X into Park by pressing the button on the end of the gear selector.

Secure the Tires

The vehicle's tires must be secured onto the truck using the eight-point tie-down method.

- Ensure any metal parts on the tie-down straps do not contact painted surfaces or the face of the wheels.
- Do not place tie-down straps over body panels or through the wheels.

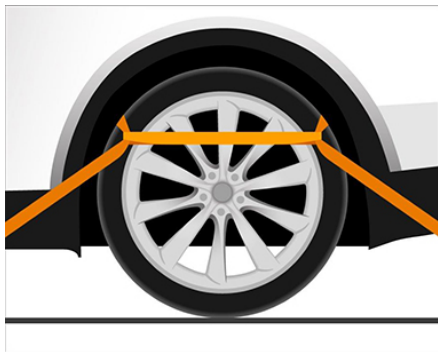

- ⚠ Caution:** Attaching tie-down straps to the chassis, suspension or other parts of the vehicle's body may cause damage.



But wait, there's more! Below is a list of the Easter Eggs that have been discovered so far and how to access them. Alternatively, touch the Tesla "T" (top center of the touchscreen) then drag the **About Your Tesla** box downwards for one-touch access to all discovered Easter Eggs.

For This...	Do This...
Santa Mode	"What have you been longing for?" Enjoy the holidays year-round with this one! Simply initiate a voice command and say "Ho Ho Ho". Or, if you are feeling extra sour, you can say "Ho Ho Ho Not Funny" instead.
Rainbow Road	Feeling nostalgic? Need more cowbell? Visit Rainbow Road by pulling the cruise stalk toward you four times in quick succession while Autosteer is enabled.
Sketchpad	Triple-tap the Tesla "T" (top center of the touchscreen) and channel your inner Picasso. Show us what you got! Touch Publish to submit your artistic compositions to Tesla for critiquing.
Mars	Press and hold the Tesla "T" (top center of the touchscreen) then enter mars in the access code popup. The map shows your Model X as a rover on the Martian landscape, and the About Your Tesla box displays SpaceX's interplanetary spaceship.
007	Press and hold the Tesla "T" (top center of the touchscreen) and enter 007 in the access code popup. You are no longer a "Driver", you're a "Diver"! Touch Controls > Suspension to change your depth.
Ludicrous Speed (P100D vehicles only)	Press and hold the Ludicrous setting (Controls > Driving > Acceleration > Ludicrous) for approximately five seconds. Touch Yes, bring it on! if you want to go fast. To display power and acceleration readings on the instrument panel, press either scroll wheel briefly until the available options are displayed. Then, roll the scroll wheel to highlight Readout then press the scroll wheel again.
The Answer to the Ultimate Question of Life, The Universe, and Everything	Rename your car to 42 (see Naming Your Vehicle on page 122) and notice the new name of your Model X.
Holiday Show	Park outside, turn the volume up, roll down your windows, then press and hold the Tesla "T" (top center of the touchscreen) and enter modelxmas in the access code popup. Enjoy the show.
Rainbow Charge Port	When Model X is locked and charging, press the button on the mobile connector ten times in quick succession. Neat, huh?



Document Applicability

Owner information is updated regularly to reflect updates to your vehicle. However, in some cases, recently released features may not be described. To display information about recently released features, view the Release Notes on the touchscreen. Release Notes are displayed on the touchscreen after a software update, and can be displayed at any time by touching the Tesla "T" at the top of the touchscreen, then touching the Release Notes link. If information related to how to use the touchscreen conflicts with information in the Release Notes, the Release Notes take precedence.

Illustrations

Illustrations are provided for demonstration purposes only. Depending on vehicle options, software version, region of purchase, and specific settings, your vehicle may appear slightly different. Although the owner information is applicable to both right-hand drive and left-hand drive vehicles, many illustrations show only left-hand drive vehicles. However, the essential information that the illustrations are providing is correct.

Errors or Inaccuracies

All specifications and descriptions are known to be accurate at time of publishing. However, because continuous improvement is a goal at Tesla, we reserve the right to make product modifications at any time. To communicate any inaccuracies or omissions, or to provide general feedback or suggestions regarding the quality of this owner information, send an email to OwnersManualFeedback@Tesla.com.

Location of Components

Owner information may specify the location of a component as being on the left or right side of the vehicle. As shown, left (1) and right (2) represent the side of the vehicle when sitting inside.

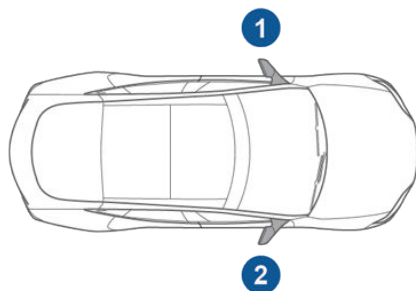

Copyrights and Trademarks

All information in this document and all vehicle software is subject to copyright and other intellectual property rights of Tesla, Inc. and its licensors. This material may not be modified, reproduced or copied, in whole or in part, without the prior written permission of Tesla, Inc. and its licensors. Additional information is available upon request. Tesla uses software created by the Open Source community. Please visit Tesla's Open Source software website at <http://www.tesla.com/opensource>. The following are trademarks or registered trademarks of Tesla, Inc. in the United States and other countries:

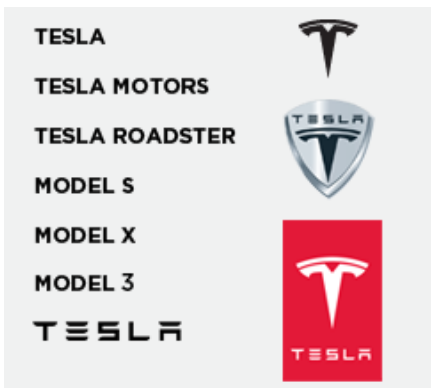

All other trademarks contained in this document are the property of their respective owners and their use herein does not imply sponsorship or endorsement of their products or services. The unauthorized use of any trademark displayed in this document or on the vehicle is strictly prohibited.



Event Data Recorder (EDR)

Model X is equipped with an event data recorder (EDR). The main purpose of an EDR is to record, in certain crash or near crash-like situations, such as an air bag deployment or hitting a road obstacle, data that will assist in understanding how a vehicle's systems performed. The EDR is designed to record data related to vehicle dynamics and safety systems for a short period of time, typically 30 seconds or less. The EDR in Model X is designed to record data such as:

- How various systems in your vehicle were operating;
- Whether or not the driver and passenger safety belts were buckled/fastened;
- How far (if at all) the driver was depressing the accelerator and/or brake pedal; and,
- How fast the vehicle was traveling.

The data can help provide a better understanding of the circumstances in which crashes and injuries occur.

Note: EDR data is recorded by your vehicle only if a non-trivial crash situation occurs; no data is recorded by the EDR under normal driving conditions and no personal data (e.g., name, gender, age, and crash location) is recorded. However, other parties, such as law enforcement, could combine the EDR data with the type of personally identifying data routinely acquired during a crash investigation.

To read data recorded by an EDR, special equipment is required, and access to the vehicle or the EDR is needed. In addition to the vehicle manufacturer, other parties, such as law enforcement, that have the special equipment, can read the information if they have access to the vehicle or the EDR.

Vehicle Telematics

Model X is equipped with electronic modules that monitor and record data from various vehicle systems, including the motor, driver assistance components, Battery, braking and electrical systems. The electronic modules record information about various driving and vehicle conditions, including braking, acceleration, trip and other related information regarding your vehicle. These modules also record information about the vehicle's features such as charging events and status, the enabling/disabling of various systems, diagnostic trouble codes, VIN, speed, direction and location.

The data is stored by the vehicle and may be accessed, used and stored by Tesla service technicians during vehicle servicing or periodically transmitted to Tesla wirelessly through the vehicle's telematics system. This data may be used by Tesla for various purposes, including, but not limited to: providing you with Tesla telematics services; troubleshooting; evaluation of your vehicle's quality, functionality and performance; analysis and research by Tesla and its partners for the improvement and design of our vehicles and systems; and as otherwise may be required by law. In servicing your vehicle, Tesla can potentially resolve issues remotely simply by reviewing your vehicle's data log.

Tesla's telematics system wirelessly transmits vehicle information to Tesla on a periodic basis. The data is used as previously described and helps ensure the proper maintenance of your vehicle. Additional Model X features may use your vehicle's telematics system and the information provided, including features such as charging reminders, software updates, and remote access to, and control of, various systems of your vehicle.

Tesla does not disclose the data recorded in your vehicle to any third party except when:

- An agreement or consent from the vehicle's owner (or the leasing company for a leased vehicle) is obtained.
- Officially requested by the police or other authorities.
- Used as a defense for Tesla in a lawsuit.
- Ordered by a court of law.
- Used for research purposes without disclosing details of the vehicle owner or identification information.



- Disclosed to a Tesla affiliated company, including their successors or assigns, or our information systems and data management providers.

In addition, Tesla does not disclose the data recorded to an owner unless it pertains to a non-warranty repair service and in this case, will disclose only the data that is related to the repair.

Data Sharing

For quality assurance and to support the continuous improvement of advanced features such as Autopilot, Tesla measures road segment data of all participating vehicles. All Tesla vehicles can learn from the experience of the billions of miles that Tesla vehicles have driven. Although Tesla shares this data with partners that contribute similar data, the data does not include any personally identifiable information about you or your vehicle. To allow data sharing, touch **Controls** > **Settings** > **Safety & Security** > **Data Sharing**, then touch the **I agree** checkbox to confirm that you agree to allowing Tesla to collect this data.

Note: Although Model X uses GPS in connection with driving and operation, as discussed in this owner's manual, Tesla does not record or store vehicle-specific GPS information. Consequently, Tesla is unable to provide historical information about a vehicle's location (for example, Tesla is unable to tell you where Model X was parked/traveling at a particular date/time).

Quality Control

You might notice a few miles/km on the odometer when you take delivery of your Model X. This is a result of a comprehensive testing process that ensures the quality of your Model X.

The testing process includes extensive inspections during and after production. The final inspection takes place at Tesla and includes a road test conducted by a technician.

California Proposition 65

Warning: Certain vehicle components contain or emit chemicals known to the State of California to cause cancer and birth defects or other reproductive harm. In addition, certain fluids contained in

vehicles and certain products of component wear contain or emit chemicals known to the State of California to cause cancer and birth defects or other reproductive harm.

Warning: Certain components of this vehicle such as airbag modules and seat belt pre-tensioners may contain Perchlorate Material. Special handling may be required for service or vehicle end of life disposal. See www.dtsc.ca.gov/hazardouswaste/perchlorate.

Warning: Battery posts, terminals, and related accessories contain lead and lead compounds. Wash hands after handling.



Contacting Tesla

For detailed information about your Model X, go to www.tesla.com, and log on to your Tesla Account, or sign up to get an account.

If you have any questions or concerns about your Model X, call 1-877-79TESLA (1-877-798-3752).

Note: You can also use voice commands to provide feedback to Tesla. Say "Note", "Report", "Bug note", or "Bug report" followed by your brief comments. Model X takes a snapshot of its systems, including your current location, vehicle diagnostic data, and screen captures of the touchscreen and instrument panel. Tesla periodically reviews these notes and uses them to continue improving Model X.

Reporting Safety Defects - US

If you believe that Model X has a defect which could cause a crash or could cause injury or death, you should immediately inform the National Highway Traffic Safety Administration (NHTSA) in addition to notifying Tesla.

If NHTSA receives similar complaints, it may open an investigation. If it finds that a safety defect exists in a group of vehicles, it may order a recall and remedy campaign. However, NHTSA cannot become involved in individual problems between you, your dealer, or Tesla.

To contact NHTSA, you may call the Vehicle Safety Hotline toll-free at 1-888-327-4236 (TTY: 1-800-424-9153); go to www.safercar.gov; or write to: Administrator, National Highway Traffic Safety, 1200 New Jersey Avenue SE., Washington, DC 20590. You can also obtain other information about motor vehicle safety from www.safercar.gov.

Reporting Safety Defects - Canada

If you believe that your Model X has a defect which could cause a crash or could cause injury or death, you should immediately inform Transport Canada, in addition to notifying Tesla. To contact Transport Canada, call their toll-free number: 1-800-333-0510.



Key and Passive Unlocking System

FCC Certification

Model Number	Mfr	GHz	Tested For
Keyfob 1048598	Tesla	2.4	USA Canada

Per FCC ID 2AEIM-1048598, the devices listed above comply with Part 15 of the FCC rules. Operation is subject to the following two conditions:

1. This device may not cause harmful interference, and
2. This device must accept any interference received, including interference that may cause undesired operation.

Changes or modifications not expressly approved by Tesla could void your authority to operate the equipment.

IC Certification

The following device is used in vehicles in Canada:

- Keyfob Model Number: 1048598 (2.4 GHz)
- Keyfob Manufacturer: Tesla

Per IC 20098-1048598, this device complies with Industry Canada license-exempt RSS standard(s). Operation is subject to the following two conditions:

1. This device may not cause harmful interference, and
2. This device must accept any interference received, including interference that may cause undesired operation.



Central Body Controller

FCC Certification

Model Number	Mfr	MHz / GHz	Tested For
Central Body Controller 1031503	Tesla	315 / 2.4	USA Canada

Per FCC ID 2AEIM-1031503, the devices listed above comply with Part 15 of the FCC rules. Operation is subject to the following two conditions:

1. This device may not cause harmful interference, and
2. This device must accept any interference received, including interference that may cause undesired operation.

Changes or modifications not expressly approved by Tesla could void your authority to operate the equipment.

IC Certification

The following device is used in vehicles in Canada:

- Central Body Controller Model Number: 1031503 (315 MHz / 2.4 GHz)
- Central Body Controller Manufacturer: Tesla

Per IC 20098-1031503, this device complies with Industry Canada license-exempt RSS standard(s). Operation is subject to the following two conditions:

1. This device may not cause harmful interference, and
2. This device must accept any interference received, including interference that may cause undesired operation.

Integral Component Only

The Central Body Controller is an integral part of the vehicle that is installed and secured around other interior trim components. The Central Body Controller is designed and intended for use only as an integral component and cannot be sold and/or marketed separately.

Tire Pressure Monitoring System

FCC IDs: TZSTPMS201, Z9F-201FS43X

IC ID: 11852A-201FS4X

The tire pressure monitoring system (TPMS) complies with Part 15 of the FCC rules and RSS-210 of Innovation, Science and Economic Development Canada. Operation is subject to the following two conditions:

1. This device may not cause harmful interference, and
2. This device must accept any interference received, including interference that may cause undesired operation.

Changes or modifications not expressly approved by Tesla could void your authority to operate the equipment.

HomeLink

This device complies with Part 15 of the FCC rules, RSS-210 Industry Canada, and with EU Directive 2014/53/EU.

Operation is subject to the following conditions:



- This device may not cause harmful interference.
- This device must accept any interference received, including interference that may cause undesired operation.

Any changes or modifications to the device not expressly approved by the manufacturer or Tesla could void your authority to operate the equipment.

Radio Frequency Information

This equipment has been tested and found to comply with the limits for a Class B digital device, pursuant to Part 15 of the FCC Rules. These limits are designed to provide reasonable protection against harmful interference in a residential installation. This equipment generates, uses and can radiate radio frequency energy and, if not installed and used in accordance with the instructions, may cause harmful interference to radio communications. However, there is no guarantee that interference will not occur in a particular installation. If this equipment does cause harmful interference to radio or television reception, which can be determined by turning the equipment off and on, try to correct the interference by one or more of the following measures:

- Reorient or relocate the receiving antenna.
- Increase the separation between the equipment and receiver.
- Connect the equipment into an outlet on a circuit different from that to which the receiver is connected.
- Consult the dealer or an experienced radio/TV technician for help.



A

- ABS (Anti-lock Braking System) [62](#)
- absolute speed limit [109](#)
- Acceleration (dual-motor) [116](#)
- Acceleration settings [68](#)
- access panel, removing [170](#)
- accessories
 - plugging into power socket [134](#)
- accessory carrier [75](#)
- adaptive headlights [59](#)
- air circulation [124](#)
- air conditioning [123](#)
- air distribution [124](#)
- air filter [128](#)
- air suspension [130](#)
- air vents [128](#)
- airbags [38](#)
- alarm [144](#)
- all-season tires [163](#)
- always connected, setting [71](#)
- anti-lock braking (ABS) [62](#)
- audio
 - playing files [131](#)
 - steering wheel buttons [44](#)
 - volume control [131](#)
- Auto High Beam [59](#)
- Auto Lane Change [96](#)
- auto-raising suspension [129](#)
- automatic emergency braking [106](#)
- Autopark [98](#)
- Autopilot components [84](#)
- Autosteer [93](#)
- average range [71](#)

B

- backup camera [73](#)
- battery (12V)
 - complete discharge [152](#)
 - specifications [182](#)
- Battery (high voltage)
 - care of [152](#)
 - coolant [170](#)
 - specifications [182](#)
 - temperature limits [152](#)
- battery (key), replacing [5](#)
- bicycle carrier [75](#)
- blind spot warning [103](#)
- Bluetooth
 - devices, playing audio files from [134](#)
 - general information [136](#)
 - phone, pairing and using [136](#)
- body repairs [173](#)
- body touch up [168](#)
- brake fluid replacement [159](#)
- brakes
 - automatic in emergencies [106](#)

- brakes (continued)
 - fluid level [170](#)
 - overview of [62](#)
 - specifications [181](#)
- brightness of displays [119](#)

C

- Cabin Overheat Protection setting [119](#)
- cabin temperature control [123](#)
- Calendar app [143](#)
- California Proposition 65 [196](#)
- camera (rear view) [73](#)
- cameras (autopilot) [84](#)
- car cover [168](#)
- car status, displaying [44](#), [45](#)
- car washes [166](#)
- cargo area [14](#)
- cargo volume [179](#)
- carpets, cleaning [167](#)
- CE certifications [198](#)
- CHAdemo [151](#)
- chains [164](#)
- change of ownership [122](#)
- charge port [154](#)
- charge port light [155](#)
- charging
 - charge settings [155](#)
 - components and equipment [150](#)
 - instructions [154](#)
 - public charging stations [151](#)
 - scheduling [155](#)
 - status of [157](#)
- charging locations, finding [139](#)
- child protection
 - disabling liftgate and rear door handles [10](#)
 - disabling rear window switches [12](#)
- child seats
 - installing and using [30](#)
- Chill acceleration [68](#)
- cleaning [166](#)
- climate controls [123](#)
- Climate Timer [127](#)
- Cold Weather controls [116](#)
- collision avoidance assist [105](#)
- console
 - 12V power socket [134](#)
 - cup holders [18](#)
 - USB ports [134](#)
- consumption chart [71](#)
- contact information
 - roadside assistance [190](#)
 - Tesla [197](#)
- coolant
 - Battery, checking level of [170](#)
 - Battery, replacement interval [159](#)
- copyrights [194](#)



Creep 116
cruise control 87
cup holders 18

D

dashboard overview 2
data recording 195
data sharing 195
day mode 119
declarations of conformity 198
delivery mileage 196
devices
 Bluetooth, playing audio files 134
 connecting 134
 playing audio files from 134
dimensions 178
display brightness 119
dome (map) lights 57
door labels 175
Door Unlock Mode 10
doors 4
doors, opening 4
Drive gear 50
drive-away locking 10
driver
 profiles 42
 seat adjustment 20
driver assistance
 Auto Lane Change 96
 automatic emergency braking 105
 Autopark 98
 Autosteer 93
 blind spot warning 103
 collision avoidance assist 105
 forward collision warning 105
 overtake acceleration 87
 overview 84
 settings for 119
 side collision warning 103
 speed assist 109
 speed limit warning 109
 staying inside lane markings 103
 staying within speed limits 109
 Traffic-Aware Cruise Control 87
driving
 seating position 20
 starting 48
 tips to maximize range 71

E

Easter Eggs 193
Easy Entry 23
easy entry, driver profile 42
EDR (event data recorder) 195
electric parking brake 63

emergency braking 105
emergency flashers 60
emergency rear door opening 11
emission label 174
energy
 gained from regenerative braking 62
 range information 51
energy & charging setting 119
Energy app 71
energy saving mode 71
Erase & Reset 122
event data recording 195
exterior
 car cover 168
 cleaning 166
 dimensions 178
 lights 57
 overview 3
 polishing, touch up, & repair 168

F

factory defaults, restoring 122
factory reset 122
fan speed, interior 124
favorite destinations 141
Favorites 138
Favorites (Media Player) 133
FCC certifications 198
features, downloading new 148
ferries, avoiding 140
firmware (software) updates 148
flash drives, playing audio files from 134
flashers, warning 60
floor mats 168
fluids
 replacement intervals 159
 reservoirs, checking 170
fog lights 57
forward collision warning 105
front passenger detection 40
front trunk 15

G

garage doors, opening 145
gates, opening 145
GAWR 176
gears 50
glove box 17
Gross Axle Weight Rating 176
Gross Vehicle Weight Rating 176
ground clearance 178
GVWR 176



H

- hazard warning flashers [60](#)
- head restraints [25](#)
- head supports [25](#)
- headlights
 - adaptive [59](#)
 - after exit [59](#)
 - high beams [59](#)
- heated wipers [61](#)
- heating [123](#)
- height adjustments (suspension)
 - auto-raising [129](#)
 - automatic and manual settings [130](#)
 - disabling (Jack mode) [130](#)
- high beam headlights [59](#)
- high voltage
 - Battery specifications [182](#)
 - components [150](#)
 - safety [159](#)
- hills, stopping on [67](#)
- Home location [141](#)
- HomeLink
 - FCC certification [199](#)
 - programming and using [145](#)
- hood [15](#)
- horn [46](#)

I

- IC certifications [198](#)
- Ideal range [119](#)
- identification labels [174](#)
- Insane acceleration (performance dual motor) [68](#)
- Insane setting (dual-motor) [116](#)
- instant range [71](#)
- instrument panel
 - charging status [157](#)
 - cleaning [167](#)
 - overview of [51](#)
- interior
 - cleaning [167](#)
 - dimensions [178](#)
 - lights [57](#)
 - overview [2](#)
 - temperature control [123](#)
- Internet radio [132](#)

J

- J1772 [151](#)
- Jack mode [130](#)
- jacking [172](#)

K

- key
 - FCC and IC certifications [198](#)
 - how to use [4](#)
 - key not inside [48](#)
 - ordering extras [7](#)
 - replacing battery [5](#)
- keyless entry [4](#)

L

- label
 - Tire and Loading Information [175](#)
 - vehicle certification [176](#)
- lane assist [103](#)
- lane change flash [60](#)
- lane change, automatic [96](#)
- lane departure warning [103](#)
- language setting [119](#)
- LATCH child seats, installing [32](#)
- Launch Mode (performance dual motor) [68](#)
- liftgate
 - adjust opening height [14](#)
 - opening [13](#)
- lifting [172](#)
- lights
 - adaptive headlights [59](#)
 - hazard warning [60](#)
 - headlights after exit [59](#)
 - turn signals [59](#)
- load limits [175](#)
- location-based suspension [129](#)
- locking and unlocking doors [4](#)
- Ludicrous acceleration (performance dual motor) [68](#)
- Ludicrous setting (dual-motor) [116](#)
- lug nut covers [163](#)
- lumbar support [20](#)

M

- maintenance
 - brake fluid, checking [170](#)
 - cleaning [166](#)
 - daily and monthly checks [159](#)
 - fluid replacement intervals [159](#)
 - panel, removing [170](#)
 - replacing wipers [169](#)
 - service intervals [159](#)
 - tires [160](#)
 - washer fluid, topping up [171](#)
- map updates [142](#)
- maps [138](#)
- mats [168](#)
- Max Battery Power [116](#)



Max Battery Power (performance dual motor)
68

media 131
mileage upon delivery 196
mirrors 47
mobile app 149
Mobile Connector
description 151
using 154
modifications 173
motor torque, reduced 107
my car does what? 193

N

naming 122
navigation 138
NCC certifications 198
Neutral gear 50
NHTSA, contacting 197
night mode 119

O

occupancy sensor 40
odometer 70
offset from speed limit 109
overhang dimensions 178
overtake acceleration 87
Owner Information, about 194

P

Park Assist 65
Park gear 50
parking brake 63
parking, automatic 98
parts replacement 173
passenger detection 40
passenger front airbag 40
Passive Entry 119
Pedal Misapplication Mitigation 105
personal data, erasing 122
phone
steering wheel buttons 45
using 136
PIN 43
power management 71
power socket 134
power windows 12
powering on and off 48
Preconditioning 119
preferences, setting 119
Proposition 65 196
public charging stations 151

R

radar 84
radio 131
Radio Frequency information 198
range
displayed on instrument panel 51
driving tips to maximize 71
regenerative braking 62
range assurance 71
Range mode 71
Range Mode 116
Rated range 119
re-routing 140
rear seats, accessing 23
rear view camera 73
rear window switches, disabling 12
Recent (Media Player) 133
Recents 138
regenerative braking 62
region format 119
relative speed limit 109
release notes 148
restarting the touchscreen 48
Reverse gear 50
RFID transponders 173
roadside assistance 190
rotating tires 161
route overview 140

S

safety defects, reporting 197
safety information
airbags 41
child seats 37
seat belts 29
satellite radio 132
seat belts
cleaning 167
in a collision 28
overview of 27
pre-tensioners 28
wearing when pregnant 28
seat covers 26
seat heaters 123
seating capacity 175
seats
adjusting 20
heaters 123
seats, second row 21
security settings 144
sensors 84
service data recording 195
service intervals 159
Settings 119
Settings, erasing 122
shifting gears 50



Show Commute Advice [140](#)
 side collision warning [103](#)
 SiriusXM [132](#)
 slip start [64](#)
 Smart Preconditioning [119](#)
 software reset [122](#)
 software updates [148](#)
 specifications
 cargo volume [179](#)
 dimensions [178](#)
 exterior [178](#)
 interior [178](#)
 motor [181](#)
 subsystems [181](#)
 tires [183](#)
 weights [179](#)
 wheels [183](#)
 speed assist [109](#)
 speed limit warning [109](#)
 spoiler [74](#)
 Sport acceleration (performance dual motor)
[68](#)
 stability control [64](#)
 Standard acceleration [68](#)
 starting [48](#)
 steering specifications [181](#)
 steering wheel
 adjusting position [44](#)
 adjusting sensitivity [44](#)
 buttons [44](#)
 heated [44](#)
 scroll wheels [44](#)
 steering, automatic [93](#)
 Streaming radio [132](#)
 summer tires [163](#)
 Summon [98](#)
 sun visors [19](#)
 supercharging
 described [158](#)
 idle fees [158](#)
 pay-per-use fees [158](#)
 suspension [130](#)
 suspension specifications [182](#)

T

telematics [195](#)
 temperature
 Battery (high voltage), limits [152](#)
 cabin, controls for [123](#)
 heated steering wheel [46](#)
 outside [51](#)
 tires [186](#)
 third row seats, folding and raising [24](#)
 tie-down straps [192](#)
 Tire and Loading Information label [175](#)
 tire noise [164](#)
 Tire Pressure Monitoring System

Tire Pressure Monitoring System (continued)
 FCC certification [199](#)
 overview of [164](#)
 tire pressures, checking [160](#)
 tire pressures, when towing [76](#)
 tires
 all-season [163](#)
 balancing [161](#)
 chains [164](#)
 inspecting and maintaining [161](#)
 pressures, how to check [160](#)
 quality grading [186](#)
 replacing [162](#)
 replacing a tire sensor [165](#)
 rotation [161](#)
 specification [183](#)
 summer [163](#)
 temperature grades [186](#)
 tire markings [184](#)
 traction grade [186](#)
 treadwear grade [186](#)
 winter [163](#)
 toll system transponders, attaching [173](#)
 tolls, avoiding [140](#)
 torque specifications [181](#)
 touch up body [168](#)
 touchscreen
 clean mode [167](#)
 cleaning [167](#)
 Controls [116](#)
 overview [111](#)
 Settings [119](#)
 software updates [148](#)
 tow eye, locating [191](#)
 Tow mode [191](#)
 towing [191](#)
 towing a trailer [76](#)
 towing capacity [76](#)
 towing instructions [191](#)
 Towing Label [175](#)
 Towing Mode [76](#)
 TPMS
 FCC certification [199](#)
 overview of [164](#)
 traction control [64](#)
 trademarks [194](#)
 Traffic-Aware Cruise Control [87](#)
 Traffic-Based Routing [140](#)
 trailer, towing [76](#)
 transmission specifications [181](#)
 transponders, attaching [173](#)
 Transport Canada, contacting [197](#)
 transporting [191](#)
 trip chart [71](#)
 trip meter [70](#)
 trip overview [140](#)
 trip planner [140](#)
 trunk, front [15](#)
 trunk, rear
 child protection lock [10](#)



trunk, rear (continued)
 disabling interior handle [10](#)
TuneIn radio [132](#)
turn signals [59](#)

U

ultrasonic sensors [84](#)
uniform tire quality grading [186](#)
Units & Format [119](#)
Unlock on Park [4](#)
unlocking and locking doors [4](#)
unlocking when key doesn't work [11](#)
USB devices
 connecting [134](#)
 playing audio files from [134](#)
USB ports [134](#)

V

Valet mode [43](#)
vehicle certification label [176](#)
Vehicle Hold [67](#)
Vehicle Identification Number (VIN) [174](#)
vehicle loading [175](#)
ventilation [128](#)
VIN (Vehicle Identification Number) [174](#)
voice commands [44](#)
volume control [111](#)
volume control (media) [131](#)

W

walk-away locking [10](#)
Wall Connector [151](#)
warning flashers [60](#)
washer fluid, topping up [171](#)
washers, using [61](#)
weight specifications [179](#)
wheel chocks [192](#)
wheels
 alignment [161](#)
 lug nut covers, removing and installing
 [163](#)
 replacing [162](#)
 specifications [183](#)
 torque [183](#)
Wi-Fi, connecting to [147](#)
windshield washer fluid, topping up [171](#)
winter tires [163](#)
wipers, de-icing [61](#)
wipers, replacing [169](#)
wipers, using [61](#)
Work location [141](#)

TESLA